

2022-2025 Product Guide

Anchoring, Fastening, Restoration and
Strengthening Systems for Concrete and Masonry

(800) 999-5099 | strongtie.com

SIMPSON

Strong-Tie



SIMPSON

Strong-Tie

CI-LV

Epoxy

**Low-Viscosity Structural
Injection Epoxy**

for repair of 0.002" – 0.25" (0.05 mm – 6 mm)
cracks in concrete

Viscosity: 350 cps @ 72°F (22°C)

**Epoxi estructural de inyección
de baja viscosidad**

para reparar fisuras desde 0.05 mm hasta 6 mm
(0.002" – 0.25") en concreto

Viscosidad: 350 cps @ 22 °C (72 °F)

Taking testing and service to new heights.

For over sixty-five years, Simpson Strong-Tie has believed the only true strength is tested strength. That's why our products are rigorously tested and load rated. But we also know every construction project is unique. So we frequently take the added step of offering full-scale application testing. Which means that whatever your design and building specs, we can create real-world conditions in our university-grade labs to make sure our products will work in your project.

It's just another example of how we exceed other manufacturers' practices to ensure your success. From design services to technical support to cutting-edge software — like Anchor Designer™ — we're uncompromising in our quest to help you design the best solution for your building challenges.



Simpson Strong-Tie Company Inc.

The Simpson Strong-Tie Company Inc. No Equal Pledge® includes:

- Quality products value-engineered for the lowest installed cost at the highest-rated performance levels
- The most thoroughly tested and evaluated products in the industry
- Strategically located manufacturing and warehouse facilities
- National code agency listings
- The largest number of patented connectors in the industry
- Global locations with an international sales team
- In-house R&D and tool and die professionals
- In-house product testing and quality control engineers
- Support of industry groups including AISI, AITC, ASTM, ASCE, AWC, AWPA, ACI, AISC, CSI, CFSEI, ICFA, NBMDA, NLBMDA, SBCA, SDI, SETMA, SFA, SFIA, STAFDA, SREA, NFBA, TPI, WDSC, WIJMA, WTCA and local engineering groups

The Simpson Strong-Tie Quality Policy

We help people build safer structures economically. We do this by designing, engineering and manufacturing No Equal® structural connectors and other related products that meet or exceed our customers' needs and expectations. Everyone is responsible for product quality and is committed to ensuring the effectiveness of the Quality Management System.



Karen Colonias
Chief Executive Officer



FM 767499

(800) 999-5099 | strongtie.com

All Rights Reserved. This guide may not be reproduced in whole or in part without the prior written approval of Simpson Strong-Tie Company Inc.

Product Identification Key

Products and additional information are divided into general categories, identified by tabs along the page's outer edge.

Adhesive Anchors

18–49 ▶

Mechanical Anchors

50–107 ▶

Direct Fastening Solutions

108–137 ▶

Restoration Solutions

138–175 ▶

Carbide Drill Bits

176–185 ▶

Appendix

186–213 ▶

Alphabetical Index of Products



214–217 ▶

Table of Contents

Adhesive Anchors

Adhesive Accessories.....	28
Adhesive Anchoring Installation Instructions.....	42
Adhesive Retaining Caps.....	35
All Thread Rod (ATR).....	41
AT-XP® Acrylic Adhesive	26
ET-HP® Epoxy Adhesive	24
Hole-Cleaning Brushes.....	31
Opti-Mesh Adhesive-Anchoring Screen Tubes.....	36
Piston Plug Delivery System	33
Retrofit Bolts (RFB).....	40
SET-3G™ Epoxy Adhesive.....	20
SET-XP® Epoxy Adhesive.....	22
Steel Adhesive-Anchoring Screen Tubes.....	38

Mechanical Anchors

Crimp Drive® Anchor.....	102
CSD/DSD Split-Drive Anchors.....	105
Drop-In Internally Threaded Anchor (DIAB).....	88
Drop-In Internally Threaded Anchor (DIA).....	94
Easy-Set Pin-Drive Expansion Anchor	71
Hollow Drop-In Anchor	96
Sleeve-All® Sleeve Anchor	68
Steel Rod Hanger.....	83
Strong-Bolt® 2 Stainless-Steel Wedge Anchor	64
Strong-Bolt 2 Wedge Anchor.....	64
Sure Wall Drywall Anchor.....	107
Tie-Wire Wedge Anchor.....	73
Titen HD® Countersunk Screw Anchor.....	54
 Titen HD Stainless-Steel Countersunk Screw Anchor	60
Titen HD Heavy-Duty Screw Anchor	52
Titen HD Stainless-Steel Heavy-Duty Screw Anchor	58
 Titen HD Washer-Head Screw Anchor.....	55
Titen® Stainless-Steel Concrete and Masonry Screw	79
 Titen Turbo™ Screw Anchor	74
Titen HD Threaded Rod Hanger	81
Titen HD Rod Coupler	62
Wood Rod Hanger	86
Zinc Nailon™ Pin Drive Anchors.....	100

New products are shown with the  symbol.

Table of Contents

Direct Fastening Solutions

Extension Pole Tools.....	120
Gas-Actuated Fasteners and Accessories	116
Gas Tool / Fastener Suitability.....	112
GCN-MEPMAGKT Concrete Nailer.....	114
Powder-Actuated Fasteners	132
Powder-Actuated Tool / Fastener Suitability.....	110
Powder-Actuated Tool / Fastener Matrix.....	131
Powder-Actuated Tool Matrix.....	121
Powder Loads.....	129
PTP-27L.....	122
PT-27	124
PT-22A	126
PT-22HA.....	128

Restoration Solutions

CIP-F Flexible Paste-Over Adhesive and Crack Sealant	154
CIP-LO Low Odor Paste-Over Epoxy and Crack Sealant.....	154
Crack Injection Guide	157
 Crack Injection Epoxy.....	140
Crack-Pac® Flex-H ₂ O™	152
Crack-Pac Injection Epoxy.....	150
Crack Repair Accessories.....	156
CSS V-Wrap™ Composite Strengthening Systems™	172
Epoxy Injection Guide	162
ETR Concrete Repair and Paste-Over Epoxy	155
Heli-Tie™ Helical Stitching Tie.....	170
Heli-Tie Helical Wall Tie.....	166

Carbide Drill Bits and Accessories

Core Bits	183
Demolition Bits	184
SDS-max® Drill Bits	181
SDS-plus® Drill Bits.....	178
Straight Shank Drill Bits	182

Appendix

Acceptable Hole Diameter	211
Anchor Products for Corrosive Environments.....	188
Anchoring and Fastening Applications by Market.....	187
Length Identification Head Marks.....	210

Important Information and General Notes

Limited Warranty

For the Limited Warranty that applies to Simpson Strong-Tie products, please consult [strongtie.com/limited-warranties](https://www.strongtie.com/limited-warranties). To obtain a copy of the current Limited Warranty, contact us at limited_warranty@strongtie.com, (800) 999-5099 or Simpson Strong-Tie Company Inc., 5956 West Las Positas Boulevard, Pleasanton, CA 94588.

The Limited Warranty contains important disclaimers, limitations and exclusions, and applies only if the products have been properly specified, installed, maintained, and used in accordance with the design limits and the structural, technical, and environmental specifications in the Simpson Strong-Tie Documentation. All future purchases of Simpson Strong-Tie products are subject to the terms of the Limited Warranty in effect as of the purchase date.

Although products are designed for a wide variety of uses, Simpson Strong-Tie assumes no liability for confirming that any product is appropriate for an intended use, and each intended use of a product must be reviewed and approved by qualified professionals. Each product is designed for the load capacities and uses listed in the Simpson Strong-Tie Documentation, subject to the limitations and other information set forth therein. Due to the particular characteristics of potential impact events such as earthquakes and high velocity winds, the specific design and location of the structure, the building materials used, the quality of construction, or the condition of the soils or substrates involved, damage may nonetheless result to a structure and its contents even if the loads resulting from the impact event do not exceed Simpson Strong-Tie's specifications and the products are properly installed in accordance with applicable building codes, laws, rules and regulations.

Important Information and General Notes

Terms and Conditions of Sale

Product Use

Products in this catalog are designed and manufactured for the specific purposes shown, and should not be used with other connectors not approved by a qualified licensed/certified building design professional, a licensed professional engineer or licensed architect (“designer”). You should review our website and consult a qualified designer familiar with all applicable building codes each time you use a Simpson Strong-Tie product.

Indemnity

Any designer or other person who modifies any products, changes any installation procedures or designs any non-catalog products for fabrication by Simpson Strong-Tie Company Inc. shall, regardless of specific instructions to the user, indemnify, defend, and hold harmless Simpson Strong-Tie Company Inc. for any and all claimed loss or damage occasioned in whole or in part by such products.

Non-Catalog and Modified Products





Modifications to products or changes in installation procedures should only be made by a qualified professional designer. The performance of such modified products or altered installation procedures is the sole responsibility of the designer. Any person modifying Simpson Strong-Tie products must provide the installer with specific instructions on the modified products’ specifications, installation and use.

Consult Simpson Strong-Tie Company Inc. for applications for which there is no catalog product, or for connectors for use in hostile environments, with excessive wood shrinkage, or with abnormal loading or erection requirements.











Non-catalog products must be designed by a qualified designer and will be fabricated by Simpson Strong-Tie in accordance with customer specifications.

Any modified, special order or non-catalog products, or any products that are not installed strictly in accordance with Simpson Strong-Tie installation procedures, are provided “AS IS” and without any representation or warranty of any kind.

Product Selection Guide





Product	Page No.	Tested Base Materials and Code Listings						Other Listings
		Concrete		Concrete on Metal Deck	CMU		Unreinforced Clay Brick Masonry	
		Cracked	Uncracked		Grout-Filled	Hollow		
SET-3G™ 	20	ESR-4057 (COLA), FL15730		—	—	—	—	ASTM C881/ AASHTO M235, DOT, CDPH Std. Method v1.2, NSF/ANSI/CAN 61
SET-XP® 	22	ESR-2508 (COLA), FL15730		—	ER-265 (COLA), FL16230	—	—	ASTM C881/ AASHTO M235, DOT, CDPH Std. Method v1.2, NSF/ANSI/CAN 61
ET-HP® 	24	ESR-3372 (COLA), FL15730		—	ER-241 (COLA), FL16230	ESR-3638 (COLA)	—	ASTM C881/ AASHTO M235, DOT
AT-XP® 	26	ER-263 (COLA), FL16230		—	ER-281 (COLA), FL16230	—	—	ASTM C881/ AASHTO M235, DOT, CDPH Std. Method v1.2, NSF/ANSI/CAN 61
Adhesive Anchors								

Product Selection Guide





ASTM C881/ AASHTO M235	ASTM C881/ AASHTO M235 NSF/ANSI/CAN 61	ASTM C881/ AASHTO M235	ASTM C881/ AASHTO M235	ASTM C881/ AASHTO M235	ASTM C881/ AASHTO M235
—	—	—	—	—	—
—	—	—	—	—	—
—	—	—	—	—	—
—	—	—	—	—	—
—	—	—	—	—	—
—	—	—	—	—	—
—	—	—	—	—	—
140	142	144	146	148	150
					
 CI-SLV	 CI-LV	 CI-LV FS	 CI-LPL	 CI-GV	Crack-Pac®
Restoration Solutions					

Refer to footnotes on p. 15.

Product Selection Guide

Product	Page No.	Tested Base Materials and Code Listings						Other Listings
		Concrete		Concrete on Metal Deck	CMU		Unreinforced Clay Brick Masonry	
		Cracked	Uncracked		Grout-Filled	Hollow		
		Cracked	Uncracked	Concrete on Metal Deck	Grout-Filled	Hollow	Unreinforced Clay Brick Masonry	
 Crack-Pac® Flex H ₂ O	152	—	—	—	—	—	—	—
 Hell-Tie™	166	—	Non-IBC	—	Non-IBC	Non-IBC	—	Wood Metal Stud
 CIP-LO	154	—	—	—	—	—	—	—
 CIP-F	154	—	—	—	—	—	—	—
 ETR	155	—	—	—	—	—	—	—
Restoration Solutions								

Product Selection Guide

Product	Page No.	Tested Base Materials and Code Listings								Other Listings
		Concrete		Concrete on Metal Deck	CMU		Unreinforced Clay Brick Masonry	Other		
		Cracked	Uncracked		Grout-Filled	Hollow				
		ESR-2713 (COLA), FL15730		ESR-1056 (COLA), FL15730	ESR-1056 (COLA), FL15730		ESR-1056 (COLA), FL15730	ESR-1056 (COLA), FL15730		
	52	ESR-2713 (COLA), FL15730			ESR-1056 (COLA), FL15730	ESR-1056 (COLA), FL15730			ESR-1056 (COLA), FL15730	ESR-1056 (COLA), FL15730
	58	ER-493 (COLA), FL16230		ESR-1056 (COLA), FL15730		ESR-1056 (COLA), FL15730	ESR-1056 (COLA), FL15730	DOT		
	54	ESR-2713 (COLA), FL15730		ESR-1056 (COLA), FL15730	ESR-1056 (COLA), FL15730				ESR-1056 (COLA), FL15730	DOT
	60	ER-493 (COLA), FL16230			ESR-1056 (COLA), FL15730	ESR-1056 (COLA), FL15730		ESR-1056 (COLA), FL15730		
	55	ESR-2713 (COLA), FL15730		ESR-1056 (COLA), FL15730		IBC			ESR-1056 (COLA), FL15730	DOT
Mechanical Anchors										

Refer to footnotes on p. 15.

Product Selection Guide





Product	Page No.	Tested Base Materials and Code Listings								Other Listings
		Concrete		Concrete on Metal Deck	CMU		Unreinforced Clay Brick Masonry	Other		
		Cracked	Uncracked		Grout-Filled	Hollow				
<p>Titan HD® Rod Coupler (THD-RC)</p>	62		ESR-2713 (COLA), FL15730	IBC					—	
<p>Titan HD Threaded Rod Hanger (THD-RH)</p>	81		ESR-2713 (COLA), FL15730	IBC					FM	
<p>Strong-Bolt® 2 (STB2)</p>	64		ESR-3037 (COLA), FL15730	ER-240 (COLA), FL16230					UL, FM, DOT	
<p>Sleeve-All® (SL)</p>	68		Non-IBC	Non-IBC					UL, FM, DOT	
<p>Easy-Set (EZAC)</p>	71		Non-IBC						—	
Mechanical Anchors										

Product Selection Guide



Mechanical Anchors					
Tie-Wire (TW)		73	—	Non-IBC	—
Titen Turbo™ (TNT)		74	—	ER-712 (COLA), FL16230	ER-716 (COLA), FL16230
Stainless-Steel Titen® (TTN)		79	—	FL2355	FL2355
Steel Rod Hanger (RSH, RSV)		83	—	—	IBC (Steel)
Wood Rod Hanger (RWH, RWW)		86	—	—	IBC (Wood)
Drop-In (DIAB)		88	—	Non-IBC	UL, FM

Refer to footnotes on p. 15.

Product Selection Guide

Product	Page No.	Tested Base Materials and Code Listings								Other Listings
		Concrete		Concrete on Metal Deck	CMU		Unreinforced Clay Brick Masonry	Other		
		Cracked	Uncracked		Grout-Filled	Hollow				
		Cracked	Uncracked	Concrete on Metal Deck	Grout-Filled	Hollow	Unreinforced Clay Brick Masonry	Other		
 Drop-In Anchor (Stainless Steel: DIA-SS) (Short: DIA-S)	94	—	Non-IBC	Non-IBC	—	—	—	—	Non-IBC (Hollow-Core Concrete Panel)	UL-FM, DOT
		—	Non-IBC	—	—	IBC	—	—	Non-IBC (Hollow-Core Concrete Panel)	UL-FM
 Hollow Drop-In (HD/A)	96	—	Non-IBC	—	—	—	—	—	—	—
		—	Non-IBC	—	—	—	—	—	—	—
 Zinc Nalton™ (ZN)	100	—	Non-IBC	—	—	—	—	—	—	—
		—	Non-IBC	—	—	—	—	—	—	—
 Crimp Drive® (CD)	102	—	Non-IBC	Non-IBC	—	—	—	—	—	FM
		—	Non-IBC	—	—	—	—	—	—	—
 Split Drive (CSD, DSD)	105	—	Non-IBC	—	—	—	—	—	—	—
		—	Non-IBC	—	—	—	—	—	—	—
Mechanical Anchors										

Product Selection Guide

Mechanical Anchors		107	—	—	—	—	—	—	—	Drywall	—
Direct Fastening	Powder-Actuated Fasteners		132	—	ESR-2138 (COLA), FL15730			—	—	Steel, ESR-2138 (COLA), FL15730	—
	Gas-Actuated Fasteners		116	—	ESR-2811 (COLA), FL15730			—	—	Steel, ESR-2811 (COLA), FL15730	—

ESR — ICC-ES code report available at icc-es.org.

ER — IAPMO UES code report available at iapmoes.org.

COLA — City of Los Angeles Supplement within the ICC-ES or IAPMO UES code report. See supplement for LA Building Code compliance.

FL — Florida building code approval available.

IBC — Load data is available in this catalog intended for use under IBC; but code listings are not available.

Non-IBC — Load data is available in this catalog, but it is outside the scope of the current IBC. May be permitted for non-IBC applications.

UL — Underwriters Laboratories listing available.

FM — Factory Mutual listing available.

DOT — Various departments of transportation listings available. See strongtie.com/DOT for details.

Consult the code listings for more detailed information on which models of each product are covered by the listing.

Anchor Software and Web Apps



Rebar Development Length Calculator

Rebar Development Length Calculator is a web application that supports the design of post-installed rebar in concrete applications by calculating the necessary tension and compression development lengths required in accordance with ACI 318-19 / ACI 318-14.



Visit: strongtie.com/softwareandwebapplications/category



Adhesive Cartridge Estimator

With the Adhesive Cartridge Estimator you can easily estimate how much adhesive you will need for your project, including threaded rod and rebar doweling, and crack injection.



Visit: strongtie.com/softwareandwebapplications/category



Anchor Designer™ Software for ACI 318, ETAG and CSA

Simpson Strong-Tie® Anchor Designer Software is the latest anchorage design tool for structural engineers to satisfy the strength design provisions and methodologies. Anchor Designer will quickly and accurately analyze an existing design or suggest anchorage solutions based upon user-defined design elements in cracked and uncracked concrete conditions.

The real-time design is visually represented in a fully-interactive 3D graphic user interface, supports Imperial and Metric-sized Simpson Strong-Tie mechanical and adhesive anchors, and offers cast-in-place anchor solutions. Anchor Designer can calculate single anchor solutions or with multiple anchors in a single plate. Anchor locations are fully customizable to assist engineers in complex design conditions.

Features include:

- Design standards:
ACI 318 Chapter 17 /
ACI 318-11 Appendix D,
CAN / CSA A23.3 Annex D,
ETAG 001 Annex C or
EOTA TR029.
- Customizable anchor
pattern.
- Easy-to-use menus.
- Ability to calculate single
anchor model or to
calculate multiple
anchor models at once.
- Multi-lingual options
include English, German,
French, Spanish, Polish
and Danish languages.
- Rectangular, circular,
L-shape and T-shape
base plate geometries
with the option to
include slotted holes.
- And much more!

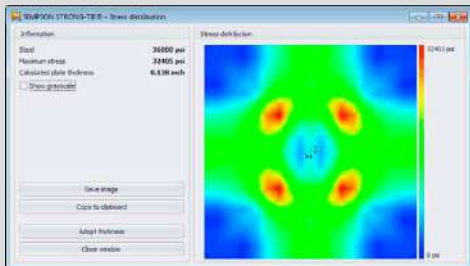
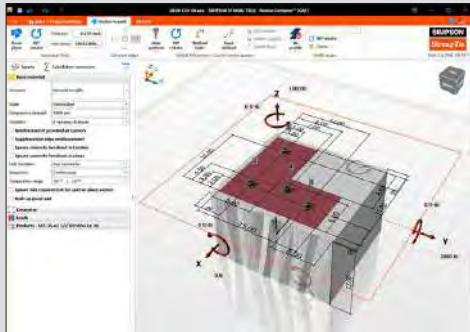

Visit: strongtie.com/softwareandwebapplications/category

Visit strongtie.com/softwareandwebapplications/category
for links to our Solutions Apps and Calculators.



Adhesive Anchors

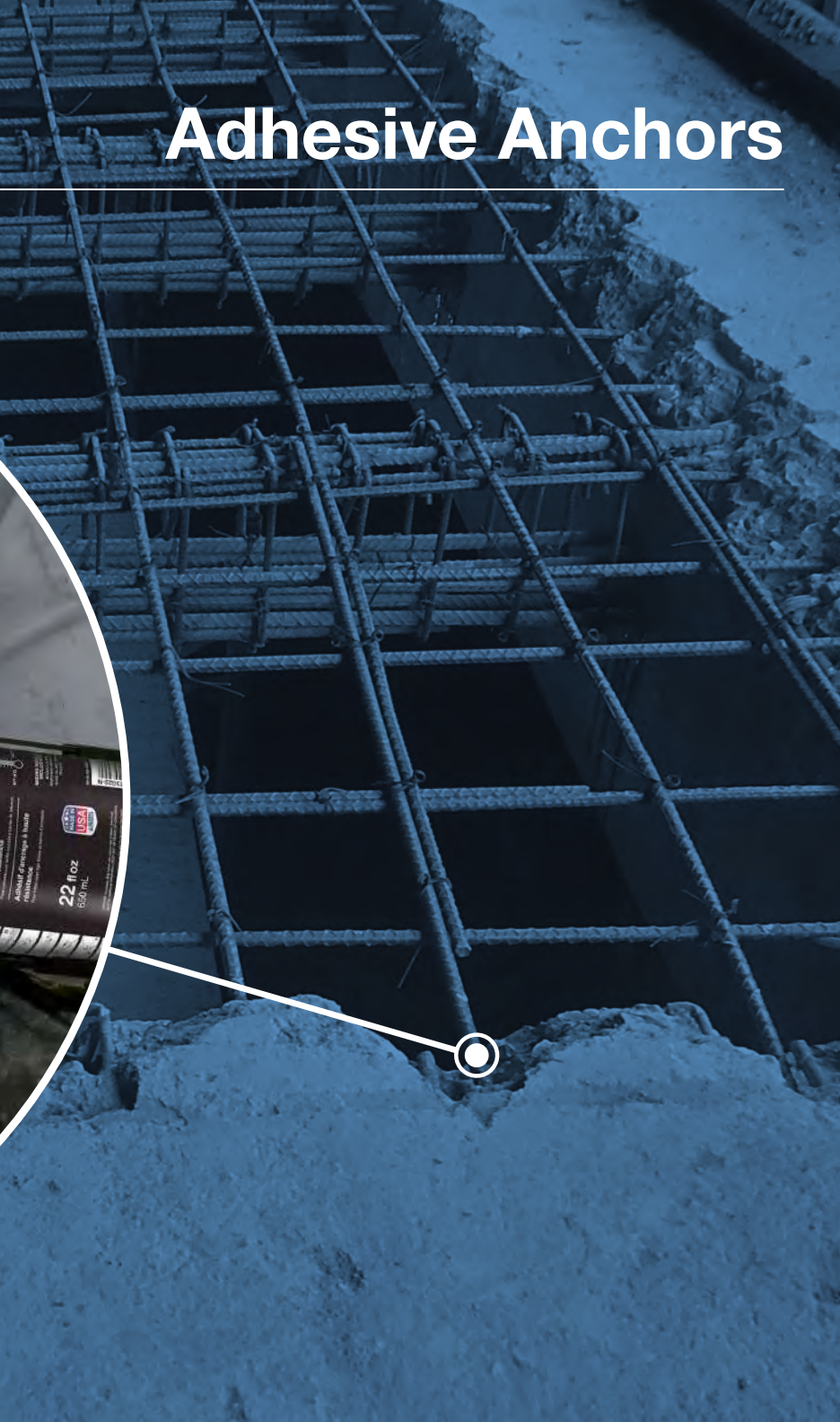

SET-3G™ High-Strength Epoxy Adhesive

SET-3G is a 1:1 ratio, two-component, high-strength, epoxy-based anchoring adhesive for cracked and uncracked concrete. SET-3G installs and performs in a variety of environmental conditions and temperature extremes.

Features

- Exceptional performance — superior bond strengths permit ductile solutions in high seismic areas
- Jobsite versatility — can be specified for all base material conditions when in-service temperatures range from -40°F (-40°C) to 176°F (80°C)
- Two-year shelf life for unopened cartridges stored between 45°F (7°C) and 90°F (32°C)
- During the installation of SET-3G, when the correct installation processes are followed, there is no performance difference between water-saturated concrete, water-filled holes, or submerged concrete
- For use with potable water

Applications

- Threaded rod anchor and rebar dowel installations in cracked and uncracked concrete
- Recognized per ICC ES AC308 for post-installed rebar development and splice length design provisions
- Installation in downward, horizontal and upwardly inclined (including overhead) orientations

Codes

Concrete — ICC-ES ESR-4057 (including post-installed rebar connections and City of LA); FL15730.

Masonry — ICC-ES ESR pending.

ASTM C881 and AASHTO M235 — Types I/IV and II/V, Grade 3, Class B&C.
NSF/ANSI/CAN 61 (216 in.² / 1,000 gal.).

Chemical Resistance

Contact Simpson Strong-Tie for information.

Installation and Application Instructions

- Surfaces to receive epoxy must be clean per approved hole cleaning method. Approved for installation with multiple vacuum drill bit systems without further hole cleaning.
- Base-material temperatures must be 40°F (4°C) or above at the time of installation. For best results, adhesive should be conditioned to a temperature between 70°F (21°C) and 80°F (37°C) at the time of installation.
- To warm cold adhesive, store cartridges in a warm, uniformly heated area or storage container. Do not immerse cartridges in water or use microwave to facilitate warming.
- Mixed material can harden in the dispensing nozzle within 30 minutes at 70°F (21°C).

Note: For full installation instructions, see product packaging or visit strongtie.com/set3g.



SET-3G Adhesive

SET-3G™ High-Strength Epoxy Adhesive

SET-3G Adhesive Cartridge System

Model No.	Capacity (ounces)	Cartridge Type	Carton Quantity	Dispensing Tool(s)	Mixing Nozzle
SET3G10 ¹	8.5	Coaxial	12	CDT10S	EMN22I
SET3G22-N ¹	22	Side-by-side	10	EDT22S, EDTA22P, EDTA22CKT	
SET3G56	56	Side-by-side	6	EDTA56P	

- One EMN22I mixing nozzle and one extension are supplied with each cartridge.
- Use only Simpson Strong-Tie® mixing nozzles in accordance with Simpson Strong-Tie instructions. Modification or improper use of mixing nozzle may impair SET-3G adhesive performance.
- Use of rodless pneumatic tools to dispense single-tube, coaxial adhesive cartridges is prohibited.
- Detailed information on dispensing tools, mixing nozzles and other adhesive accessories is available at strongtie.com.
- Cartridge estimation guidelines are available at strongtie.com/apps.

SET-3G Cure Schedule^{1,2}

Concrete Temperature		Gel Time	Cure Time
(°F)	(°C)	(minutes)	(hours)
40	4	120	192
50	10	75	72
60	16	50	48
70	21	35	24
90	32	25	24
100	38	15	24

For SI: 1°F = (°C x 9/5) + 32.

- For water-saturated concrete, water-filled holes and submerged concrete, the cure times should be doubled.
- For installation of anchors in concrete where the temperature is below 70°F (21°C), the adhesive must be conditioned to a minimum temperature of 70°F (21°C).

SET-XP® High-Strength Epoxy Adhesive

SET-XP is a 1:1 ratio, two-component, high-strength, epoxy-based anchoring adhesive for anchoring and doweling in cracked and uncracked concrete and masonry applications.

Features

- Design flexibility — permitted for sustained load performance at elevated temperature
- Suitable for use in dry or water-saturated concrete
- Two-year shelf life for unopened cartridges stored between 45°F (7°C) and 90°F (32°C)

Applications

- Threaded rod anchoring and rebar doweling into concrete and masonry
- Recognized per AC308 to be used for rebar development and splice length design provisions of ACI 318
- Installation in downward, horizontal and upwardly inclined (including overhead) orientations

Codes

Concrete — ICC-ES ESR-2508 (including post-installed rebar and City of LA Report); FL15730.

Masonry — IAPMO UES ER-265 (including City of LA Report); FL16230; ICC-ES ESR pending.

ASTM C881 and AASHTO M235 — Types I/IV and II/IV, Grade 3, Class C.

NSF/ANSI/CAN 61 (216 in.² / 1,000 gal.).

Installation and Application Instructions

- Surfaces to receive epoxy must be clean per approved hole cleaning method. Approved for installation with multiple vacuum drill bit systems without further hole cleaning.
- Base material temperature must be 50°F (10°C) or above at the time of installation. For best results, material should be between 70°F (21°C) and 80°F (27°C) at time of application.
- To warm cold material, store cartridges in a warm, uniformly heated area or storage container. Do not immerse cartridges in water or use microwave to facilitate warming.
- Mixed material in nozzle can harden in 30 minutes at temperatures of 70°F (21°C).

Suggested Specifications

See strongtie.com for more information.



SET-XP Adhesive

SET-XP® High-Strength Epoxy Adhesive

SET-XP Cartridge System

Model No.	Capacity (ounces)	Cartridge Type	Carton Quantity	Dispensing Tool(s)	Mixing Nozzle
SET-XP10 ¹	8.5	Single	12	CDT10S	EMN22I
SET-XP22-N ¹	22	Side-by-Side	10	EDT22S, EDTA22P, EDTA22CKT	
SET-XP56	56	Side-by-Side	6	EDTA56P	

1. One EMN22I mixing nozzle and one extension are supplied with each cartridge.
2. Use only Simpson Strong-Tie® mixing nozzles in accordance with Simpson Strong-Tie instructions. Modifications or improper use of mixing nozzle may impair SET-XP adhesive performance.
3. Use of rodless pneumatic tools to dispense single-tube, coaxial adhesive cartridges is prohibited.
4. Detailed information on dispensing tools, mixing nozzles and other adhesive accessories is available at strongtie.com.
5. Cartridge estimation guidelines are available at strongtie.com/apps.

Cure Schedule

Base Material Temperature		Gel Time (minutes)	Cure Time (hours)
°F	°C		
50	10	75	72
60	16	60	48
70	21	45	24
90	32	35	24
110	43	20	24

1. For water-saturated concrete, the cure times must be doubled.

ET-HP® Epoxy Adhesive

ET-HP is a two-component, high-solids, epoxy-based system for use as a high-strength, non-shrink anchor-grouting material. ET-HP is formulated for anchoring and doweling in cracked and uncracked concrete and masonry applications.

Features

- Suitable for use under static and seismic loading conditions in cracked and uncracked concrete and masonry
- Suitable for use in dry or water-saturated concrete
- Two-year shelf life for unopened cartridges stored between 45°F (7°C) and 90°F (32°C)

Applications

- Threaded rod anchoring and rebar doweling into concrete and unreinforced masonry
- Installation in downward, horizontal and upwardly inclined (including overhead) orientations

Codes

Concrete — ICC-ES ESR-3372 (including City of LA); FL15730.

Masonry — IAPMO UES ER-241 (including Florida Supplement); FL16230.

Unreinforced Masonry (URM) — ICC-ES ESR-3638.

ASTM C881 and AASHTO M235 — Types I/IV, II/V, Class B and C, Grade 3.

Installation and Application Instructions

- Surfaces to receive epoxy must be clean per approved hole cleaning method.
- Base material temperature must be 50°F (10°C) or above at the time of installation. For best results, material should be between 70°F (21°C) and 80°F (27°C) at time of application.
- To warm cold material, store cartridges in a warm, uniformly heated area or storage container. Do not immerse cartridges in water or use microwave to facilitate warming.
- Mixed material in nozzle can harden in 15 minutes at temperatures of 70°F (21°C).

Suggested Specifications

See strongtie.com for more information.



ET-HP Adhesive

ET-HP® Epoxy Adhesive

ET-HP Package Systems

Model No.	Capacity (ounces)	Package Type	Carton Quantity	Dispensing Tools	Mixing Nozzle
ET-HP22-N ¹	22	Side-by-side	10	EDT22S, EDTA22P, EDTA22CKT	EMN22I

1. One EMN22I mixing nozzle and one extension are supplied with each cartridge.
2. Use only Simpson Strong-Tie® mixing nozzles in accordance with Simpson Strong-Tie instructions. Modifications or improper use of mixing nozzle may impair ET-HP adhesive performance.
3. Detailed information on dispensing tools, mixing nozzles and other adhesive accessories is available at strongtie.com.
4. Cartridge estimation guidelines are available at strongtie.com/apps.

Cure Schedule

Base Material Temperature		Gel Time (minutes)	Cure Time ¹ (hours)
°F	°C		
50	10	45	72
60	16	30	24
80	27	20	24
100	38	15	24

1. For water-saturated concrete, the cure times must be doubled.

AT-XP® High-Strength Acrylic Adhesive

AT-XP is a 10:1 ratio, two-component, high-strength acrylic-based anchoring adhesive for use in threaded rod and rebar into cracked and uncracked concrete and masonry under a wide range of conditions. AT-XP adhesive dispenses easily in cold or warm environments and in below-freezing temperatures with no need to warm the cartridge.

Features

- Suitable for use in dry or water-saturated concrete.
- One-year shelf life for unopened cartridges (13 oz. and 30 oz.) when stored between 14°F (–10°C) and 80°F (27°C). Eighteen-month shelf life for unopened cartridges (10 oz.) when stored between 14°F (–10°C) and 80°F (27°C).
- Cures in substrate temperatures as low as 14°F in 24 hours or less. Cures in 30 minutes at 86°F.

Applications

- Threaded rod anchoring and rebar doweling into concrete and masonry
- Installation in downward, horizontal and upwardly inclined (including overhead) orientations

Codes

Concrete — IAPMO UES ER-263 (including City of LA); FL16230.

Masonry — IAPMO UES ER-281 (including City of LA and Florida Building Code Supplement); FL16230.

ASTM C881 and AASHTO M235 — Types I/IV, Grade 3, Class A, B, and C except AT-XP is not an epoxy.

NSF/ANSI/CAN 61 (43.2 in.² / 1,000 gal.).

Installation and Application Instructions

- Surfaces to receive adhesive must be clean per approved hole cleaning method. Approved for installation with vacuum drill bit system without further hole cleaning.
- Base material temperature must be 14°F (–10°C) or above at the time of installation. For best results, material should be between 14°F (–10°C) and 80°F (27°C) at time of application.
- To warm cold material, store cartridges in a warm, uniformly heated area or storage container. Do not immerse cartridges in water or use microwave to facilitate warming.
- Mixed material in nozzle can harden in 3–4 minutes at temperatures of 70°F (21°C).

Suggested Specifications

See strongtie.com for more information.



AT-XP Adhesive

AT-XP® High-Strength Acrylic Adhesive

AT-XP Adhesive Cartridge System

Model No.	Capacity ounces (cubic in.)	Cartridge Type	Carton Qty.	Dispensing Tool	Mixing Nozzle
AT-XP10 ¹	9.4 (16.9)	Coaxial	6	CDT10S	AMN19Q
AT-XP13 ¹	12.5 (22.5)	Side-by-side	10	ADT813S	
AT-XP30 ¹	30 (54)	Side-by-side	5	ADT30S ADTA30P or ADTA30CKT	

1. One AMN19Q mixing nozzle with integrated extension is supplied with each cartridge.
2. Use only Simpson Strong-Tie® mixing nozzles in accordance with Simpson Strong-Tie instructions. Modifications or improper use of mixing nozzle may impair AT-XP adhesive performance.
3. Use of rodless pneumatic tools to dispense single-tube, coaxial adhesive cartridges is prohibited.
4. Detailed information on dispensing tools, mixing nozzles and other adhesive accessories is available at strongtie.com.
5. Cartridge estimation guidelines are available at strongtie.com/apps.

Cure Schedule

Base Material Temperature		Gel Time (minutes)	Cure Time (hours)
°F	°C		
14	-10	30	24
32	0	15	8
50	10	7	3
68	20	4	1
86	30	1½	30 min.
100	38	1	20 min.

1. For water-saturated concrete, the cure times must be doubled.

Adhesive Accessories

Adhesive Dispensing Tools

Our heavy-duty tools are designed to work with our cartridges for trouble-free dispensing. Each manual tool provides a 26:1 drive mechanism for easier dispensing of high-viscosity adhesive.

CDT10S**Manual Dispensing Tool for Single Cartridge Adhesives**

The CDT10S features a steel carriage for ultimate durability and is engineered for continuous, high-volume use, as well as double-gripping plates that help extend tool life.



CDT10S

EDT22S**Manual Dispensing Tool for 22 oz. Adhesive Cartridges**

The EDT22S epoxy adhesive tool features a steel carriage and is engineered for high-volume, continuous use. The tool can be easily converted (conversion parts included) from dispensing a 22 oz., 1:1 ratio cartridge to a 16.5 oz., 2:1 ratio cartridge.



EDT22S

EDTA22CKT**Battery-Powered Dispensing Tool for 22 oz. Cartridges**

The EDTA22CKT offers power dispensing of 22 oz., 1:1 ratio, dual-cartridge adhesives without the need for a hose or compressor. The 18V lithium-ion battery is 50% lighter than NiCad and offers 40% longer run time and 30-minute recharging. Tool converts to dispense 16.5 oz., 2:1 ratio dual-cartridge adhesives (conversion parts included). The EDTA22CKT comes with the dispensing tool, two 18V lithium-ion battery packs and a charger.

EDTA22CKT
Tool and Charger**EDTA22P****Pneumatic Dispensing Tool for 22 oz. Cartridges**

The EDTA22P tool features an optional suitcase handle adapter for the ultimate in tool configuration and dispensing convenience, enabling easier and time-saving ground-level doweling. The heavy-duty tool comes with a custom, blow-molded plastic carrying case.



EDTA22P

EDTA56P**Pneumatic Dispensing Tool for 56 oz. Cartridges**

The EDTA56P tool features an optional suitcase handle adapter for the ultimate in tool configuration and dispensing convenience, enabling easier and time-saving ground-level doweling. The heavy-duty tool comes with a custom, blow-molded plastic carrying case.



EDTA56P

Description	Model No.
Premium tool for single-tube cartridges	CDT10S
Manual tool for 22 oz. cartridges	EDT22S
Battery-powered tool for 22 oz. cartridges	EDTA22CKT
Pneumatic tool for 22 oz. cartridges ^{1,2}	EDTA22P
Pneumatic tool for 56 oz. cartridges ^{1,2}	EDTA56P

1. Air supply attachment is 1/4-18 NPT (male) thread.
2. Recommended operating air pressure is between 80 and 100 psi.

Maintenance tips, troubleshooting and repair parts schematics available at strongtie.com.

Adhesive Accessories

ADT813S

Manual Dispensing Tool for 12.5 oz. Cartridges

The ADT813S features a steel carriage for ultimate durability. The ADT813S also features double-gripping plates that help extend tool life.



ADT813S

ADT30S

Manual Dispensing Tool for 30 oz. Adhesive Cartridges

The ADT30S features a steel carriage for ultimate durability and is engineered for continuous, high-volume use, as well as double-gripping plates that help extend tool life. The tool can be easily converted from 30 oz. 10:1 cartridges to 32 oz. 2:1 cartridges (conversion parts included).



ADT30S

ADTA30CKT

Battery-Powered Dispensing Tool for 30 oz. Cartridges

The ADTA30CKT offers power dispensing of 30 oz., 10:1 ratio, dual-cartridge adhesives without the need for a hose or compressor. The tool features dosage and rate control for maximum efficiency on the job. The 18V lithium-ion battery is 50% lighter than NiCad and offers 40% longer run time. Recharging takes only 30 minutes. The ADTA30CKT comes with the dispensing tool, two 18V Lithium-ion battery packs a charger and parts to easily convert from 30 oz. 10:1 cartridges to 32 oz. 2:1 cartridges.



ADTA30CKT

ADTA30P

Pneumatic Dispensing Tool for 30 oz. Cartridges

The ADTA30P tool features an optional suitcase handle adapter for flexible tool configuration and dispensing convenience. The suitcase option enables easier and time-saving ground-level doweling. The heavy-duty tool comes with a custom, blow-molded plastic carrying case. The tool can be easily converted from 30 oz. 10:1 cartridges to 32 oz. 2:1 cartridges (conversion parts included).



ADTA30P

Description	Model No.
Manual tool for 12.5 oz. cartridges	ADT813S
Manual tool for 30 oz. 10:1 cartridges and 32 oz. 2:1 cartridges	ADT30S
Battery-powered tool for 30 oz. 10:1 cartridges and 32 oz. 2:1 cartridges	ADTA30CKT
Pneumatic tool for 30 oz. cartridges ^{1,2}	ADTA30P

1. Air supply attachment is ¼-18 NPT (male) thread.

2. Recommended operating air pressure is between 80 and 120 psi.

Maintenance tips, troubleshooting and repair parts schematics available at strongtie.com.

Adhesive Nozzle Accessories

EMN22i

An 18-element mixing nozzle with integrated nut for use with 10 oz., 22 oz. and 56 oz. epoxy adhesive cartridges.



EMN22i

Model No.	Option	Package Quantity	Carton Quantity
EMN22i	Single mixing nozzle for epoxy products.	1	12
EMN22i-RP10	Ten mixing nozzles for epoxy products.	10	3
EMN22i-RP5	Five mixing nozzles for epoxy products.	5	6
EMN22iB	Five hundred mixing nozzles for epoxy products.	500	500

EMN50

An 18-element high-volume mixing nozzle with integrated nut for use with 22 oz. and 56 oz. epoxy adhesive cartridges.



EMN50

Model No.	Option	Package Quantity
EMN50	High-volume nozzle for 22 oz. and 56 oz. cartridges (separate retaining nut not required), 17" long, major diameter 7/8".	10

AMN19Q

A 19-element high-strength static mixing nozzle with integrated nut for use with all acrylic adhesive products.



AMN19Q

Model No.	Option	Package Quantity	Carton Quantity
AMN19Q-RP5	Five mixing nozzles for AT-XP® product.	5	10

Adhesive Accessories

Hole-Cleaning Brushes

Brushes are used for cleaning drilled holes prior to adhesive installation.

Note: The standard hole-cleaning method (blow-brush-blow) can be avoided by using an approved vacuum drill bit system. See product pages on strongtie.com for approved vacuum drill bit systems.

Wire Brush — Standard

(For use with SET-3G)

Model No.	Hole Diameter (in.)	Anchor Diameter (in.)	Rebar Size	Usable Length (in.)	Carton Quantity
ETB43S	7/16	3/8	—	5	25
ETB50S	1/2	—	#3	5	25
ETB56S	9/16	1/2	—	5	25
ETB62S	5/8	—	#4	5	25
ETB68S	11/16	5/8	—	5	25
ETB75S	3/4	—	#5	5	25
ETB87S	7/8	3/4	#6	5	25
ETB100S	1	7/8	#7	5	25
ETB112S	1 1/8	1	#8	5	25
ETB137S	1 3/8	1 1/4	#10	5	25
ETBS-TH	T-handle			8 1/2	25
ETBS-EXT	Extension			11 1/2	25

1. T-handle is required for use with all sizes of standard wire brush.

2. To obtain total usable length, add the usable length for each part used.



Adhesive Accessories

Hole-Cleaning Brushes (cont.)

Nylon Brush — Standard

(For use with SET-XP®, AT-XP® and ET-HP®)

Model No.	Hole Diameter (in.)	Anchor Diameter (in.)	Rebar Size	Usable Length (in.)	Carton Quantity
ETB4	3/8 – 7/16	1/4 – 5/16	—	7	24
ETB6	1/2 – 3/4	3/8 – 5/8	#3 – #5	15	24
ETB8	13/16 – 7/8	3/4	#6	15	24
ETB8L	13/16 – 7/8	3/4	#6	23	24
ETB10	1 – 1 1/8	7/8 – 1	#7 – #8	28	24
ETB12	1 3/16 – 1 3/8	1 1/4	#10	33	24

1. All standard nylon brushes are one-piece which includes a twisted wire handle.



Nylon Brush — Rebar

(For use with SET-XP and SET-3G™)

(Note: Brushes are only applicable for SET-3G when used for post-installed rebar connections.)

Model No.	Hole Diameter (in.)	Rebar Size	Usable Length (in.)	Carton Quantity
ETB6R	1/2 – 3/4	#3 – #5	6	25
ETB8R	7/8	#6	6	25
ETB10R	1 – 1 1/8	#7 – #8	8	25
ETB12R	1 3/8	#10	8	25
ETB14R	1 3/4	#11	7	25
ETBR-EXT	T-handle and extension		35 1/4	25

1. ETBR-EXT is required for use with all sizes of rebar nylon brushes.
2. To obtain total usable length, add the usable length for each part used.
3. Brushes are used when rebar is installed to replace cast-in-place bar for lap splices and development length.



Adhesive Accessories

Piston Plug Delivery System

The Simpson Strong-Tie® Piston Plug Delivery System for adhesives offers you an easy-to-use, reliable and less time-consuming means to dispense adhesive into drilled holes for threaded rod and rebar dowel installations in overhead, upwardly inclined and horizontal orientations. The matched tolerance design between the piston plug and drilled hole virtually eliminates the formation of voids and air pockets during adhesive dispensing.

The Piston Plug Delivery System consists of three components: piston plug, flexible extension tubing, and adhesive retaining cap.



Features

- Designed for dispensing adhesive into drilled holes in overhead, upwardly inclined and horizontal orientations, as well as deep embedments
- Suitable for use with all Simpson Strong-Tie anchoring adhesives
- Adhesive piston plugs are sized to fit each drilled hole diameter
- Model number is embossed on each adhesive piston plug for identification
- A barbed end provides a reliable connection to the flexible extension tubing
- Flexible extension tubing is available in 25-foot-long rolls to be cut to required lengths



Use the piston plug delivery system with all Simpson Strong-Tie adhesive products:



SET-3G™



SET-XP®



AT-XP®



ET-HP®

Adhesive Accessories

Piston Plug Delivery System (cont.)

Piston Plugs

Model No.	Hole Size (in.)	Pkg. Quantity	Carton Quantity*
PP56-RP10	$\frac{9}{16}$	10	10 packs of 10
PP62-RP10	$\frac{5}{8}$	10	10 packs of 10
PP68-RP10	$1\frac{1}{16}$	10	10 packs of 10
PP75-RP10	$\frac{3}{4}$	10	10 packs of 10
PP81-RP10	$1\frac{1}{16}$	10	10 packs of 10
PP87-RP10	$\frac{7}{8}$	10	10 packs of 10
PP100-RP10	1	10	10 packs of 10
PP112-RP10	$1\frac{1}{8}$	10	10 packs of 10
PP137-RP10	$1\frac{3}{8}$	10	10 packs of 10
PP175-RP10	$1\frac{3}{4}$	10	10 packs of 10

*Product is sold by package.



Piston Plugs

Tubing

Model No.	Description	Package Quantity
PPFT25	Piston Plug Flexible Extension Tubing — 25 ft. roll	1



Piston Plug Flexible Extension Tubing

1. Tubing dimensions: inner diameter $\frac{3}{8}$ ", outer diameter $\frac{1}{2}$ ".

Adhesive Accessories

Adhesive Retaining Caps

Adhesive retaining caps make overhead and horizontal installation easier by preventing the adhesive from running out of the hole. They also center the rod in the hole, making them ideal for applications where precise anchor placement is required. It may be necessary to provide support for the anchor during cure time. Adhesive retaining caps are not designed to support the weight of the anchor in overhead installations. Adhesive retaining caps should be used for horizontal and overhead adhesive installations. ARCs may be used in conjunction with the Piston Plug Delivery system.



Adhesive Retaining Caps

Retaining Caps

Model No.	Hole Size (in.)	Anchor Dia. (in.)	Rebar Size	Cap Depth (in.)	Package Quantity	Carton Quantity* (each)
ARC37A-RP25	$\frac{7}{16}$	$\frac{3}{8}$	#3	$\frac{7}{16}$	25	8 packs of 25
ARC37-RP25	$\frac{1}{2}$	$\frac{3}{8}$		$\frac{7}{16}$	25	8 packs of 25
ARC50A-RP25	$\frac{9}{16}$	$\frac{1}{2}$	#4	$\frac{1}{2}$	25	8 packs of 25
ARC50-RP25	$\frac{5}{8}$	$\frac{1}{2}$		$\frac{1}{2}$	25	8 packs of 25
ARC62A-RP25	$1\frac{1}{16}$	$\frac{5}{8}$	#5	$\frac{9}{16}$	25	8 packs of 25
ARC62-RP25	$\frac{3}{4}$	$\frac{5}{8}$		$\frac{9}{16}$	25	8 packs of 25
ARC75A-RP25	$1\frac{3}{16}$	$\frac{3}{4}$	#6	$\frac{9}{16}$	25	8 packs of 25
ARC75-RP25	$\frac{7}{8}$	$\frac{3}{4}$		$\frac{9}{16}$	25	8 packs of 25
ARC87-RP25	1	$\frac{7}{8}$	#7	$1\frac{1}{16}$	25	8 packs of 25
ARC100A-RP25	$1\frac{1}{16}$	1	#8	$1\frac{1}{16}$	25	8 packs of 25
ARC100-RP25	$1\frac{1}{8}$	1		$1\frac{1}{16}$	25	8 packs of 25
ARC125-RP25	$1\frac{3}{8}$	$1\frac{1}{4}$	#10	$\frac{7}{8}$	25	8 packs of 25
ARC137-RP25	$1\frac{3}{4}$	—	#11	$1\frac{1}{16}$	25	8 packs of 25

*Product is sold by package.

Adhesive Accessories

Opti-Mesh Adhesive-Anchoring Screen Tubes

Screen tubes are vital to the performance of adhesive anchors in base materials that are hollow or contain voids, such as hollow block and brick. The Simpson Strong-Tie® Opti-Mesh screen tube with woven mesh insert provides the advantages of a plastic screen tube while providing superior performance to steel screen tubes and competitive plastic screen tubes.

Material: Plastic



Caution: Screen tubes are designed for specific Simpson Strong-Tie anchoring adhesives (see below).



Integral Cap: Serves to center and secure the rod in the screen tube, while displaying important information such as rod diameter, drill bit diameter and the Simpson Strong-Tie “#” symbol for easy inspection after installation. The cap also prevents adhesive from running out the front of the screen tube.

Flanges: Prevents the screen tube from slipping into over-drilled holes.

Open-Mesh Collar: This section of larger mesh allows extra adhesive to flow out the screen tube behind the face shell of hollow block applications. The extra “collar” of adhesive increases bearing area and results in higher load capacities in hollow concrete block.

Color-Coded, Formula-Specific Mesh: The openings between the woven mesh screen tube strands are sized to allow only the right amount of adhesive to flow through the screen tube to bond with the base material while the balance remains in the screen to bond the rod.

EWSP
Epoxy Adhesive
Screen Tube
(mesh is black)
For use
with SET-XP
US Patent:
6,837,018



AWSP Acrylic
Adhesive Screen Tube
(mesh is white)
For use with AT-XP



The integral cap centers the rod and displays drill bit and rod diameter.



3GWSP
Adhesive
Screen Tube
*(gray frame
with gray mesh)*
For use with
SET-3G™



Adhesive Accessories

Screen Tubes — Plastic

For Rod Diameter (in.)	Hole Size (in.)	Length (in.)	EWS Model No. for SET-XP®	AWS Model No. for AT-XP®	3GWS Model No. for SET-3G™	Carton Quantity
3/8	9/16	3 1/2	EWS373P	AWS373P	3GWS373P	150
		6	EWS376P	AWS376P	3GWS376P	150
		10	EWS3710P	AWS3710P	3GWS3710P	100
1/2	3/4	3 1/2	EWS503P	AWS503P	3GWS503P	100
		6	EWS506P	AWS506P	3GWS506P	100
		10	EWS5010P	AWS5010P	3GWS5010P	50
5/8	7/8	3 1/2	EWS623P	AWS623P	3GWS623P	50
		6	EWS626P	AWS626P	3GWS626P	50
		10	EWS6210P	AWS6210P	3GWS6210P	25
3/4	1	8	EWS758P	AWS758P	3GWS758P	25
		13	EWS7513P	AWS7513P	3GWS7513P	25



Specially sized holes in Opti-Mesh screens allow for adhesive to seep out at the appropriate location at the hollow portion of the CMU to create a better bond to the face shell.

Adhesive Accessories

Steel Adhesive-Anchoring Screen Tubes

Screen tubes are used in hollow base material applications to contain adhesive around the anchor and prevent it from running into voids. Simpson Strong-Tie® screen tubes are specifically designed to work with AT-XP® and ET-HP® adhesives in order to precisely control the amount of adhesive that passes through the mesh. This results in thorough coating and bonding of the rod to the screen tube and base material. Order screen tubes based upon rod diameter and adhesive type. The actual outside diameter of the screen tube is larger than the rod diameter.

Material: ATS screen tubes: 50 mesh stainless steel
ETS screen tubes: 60 mesh carbon steel



Caution: Screen tubes are designed for a specific adhesive type. ETS screen tubes must be used with ET-HP formulations and ATS screen tubes must be used with AT-XP.

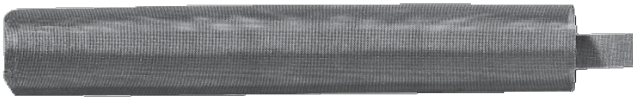

Screen Tube

Screen tubes are for use in hollow CMU, hollow brick and unreinforced masonry applications.

Adhesive Accessories

Screen Tubes

For Rod Diameter (in.)	Hole Size (in.)	ATS Stainless Steel Screen Tubes for AT-XP		ETS Carbon Steel Screen Tubes for ET-HP (SET-XP® 3/4" Rod Sizes)		Carton Quantity
		Actual Screen Size O.D./Length (in.)	Model No.	Actual Screen Size O.D./Length (in.)	Model No.	
3/8	9/16	—	—	15/32 X 6	ETS376	150
		—	—	15/32 X 10	ETS3710	100
1/2	11/16	—	—	19/32 X 6	ETS506	100
		—	—	19/32 X 10	ETS5010	50
5/8	7/8	—	—	25/32 X 6	ETS626	50
		—	—	25/32 X 10	ETS6210	25
		—	—	25/32 X 13	ETS6213	25
3/4	1	31/32 X 8	ATS758	31/32 X 8	ETS758	25
		31/32 X 13	ATS7513	31/32 X 13	ETS7513	25
		31/32 X 17	ATS7517	31/32 X 17	ETS7517	25
		—	—	31/32 X 21	ETS7521	25

Adhesive Accessories

Retrofit Bolts

RFBs are pre-cut threaded rod, supplied with nut and washer. Each end of the threaded rod is stamped with the rod length in inches and our No-Equal® symbol for easy identification after installation.

Material: ASTM F1554 Grade 36, A36 or A307
min $f_y = 36$ ksi, min $F_u = 58$ ksi and not to exceed 80 ksi

Coating: Zinc-plated, hot-dip galvanized



RFB
Retrofit Bolts

Size (in.)	Zinc-Plated Model No.	Hot-Dip Galvanized Model No.	Carton Quantity	Hot-Dip Galvanized Retail Model No.*	Package Quantity	Carton Quantity
3/8 x 4	RFB#3x4	RFB#3x4HDG	50	—	—	—
3/8 x 6	RFB#3x6	—	50	—	—	—
3/8 x 8	RFB#3x8	—	50	—	—	—
1/2 x 4	RFB#4x4	—	50	—	—	—
1/2 x 5	RFB#4x5	RFB#4x5HDG	50	RFB#4x5HDGP2	2	5 packs of 2
1/2 x 6	RFB#4x6	RFB#4x6HDG	50	—	—	—
1/2 x 7	RFB#4x7	RFB#4x7HDG	50	—	—	—
1/2 x 8	RFB#4x8	RFB#4x8HDG	50	RFB#4x8HDGP2	2	5 packs of 2
1/2 x 10	RFB#4x10	RFB#4x10HDG	25	—	—	—
5/8 x 5	RFB#5x5	RFB#5x5HDG	50	RFB#5x5HDGP2	2	5 packs of 2
5/8 x 8	RFB#5x8	RFB#5x8HDG	50	RFB#5x8HDGP2	2	5 packs of 2
5/8 x 10	RFB#5x10	RFB#5x10HDG	50	—	—	—
5/8 x 12	—	RFB#5x12HDG	25	RFB#5x12HDGP2	2	5 packs of 2
5/8 x 16	RFB#5x16	RFB#5x16HDG	25	RFB#5x16HDGP2	2	5 packs of 2
3/4 x 6	RFB#6x6	—	50	—	—	—
3/4 x 8	RFB#6x8	RFB#6x8HDG	50	—	—	—
3/4 x 10 1/2	RFB#6x10.5	RFB#6x10.5HDG	25	—	—	—

*Retail products ("P2") packaged in a polybag.

Adhesive Accessories

All Thread Rod

ATRs are pre-cut threaded rod for use with Simpson Strong-Tie® adhesives.

Material: ASTM F1554 Grade 36, A36 or A307

min $f_y = 36$ ksi, min $F_u = 58$ ksi and not to exceed 80 ksi

Coating: Uncoated, zinc-plated; hot-dip galvanized



ATR
All Thread Rod

Description Dia. x Length (in.)	Uncoated Model No.	Zinc-Plated Model No.	Hot-Dip Galvanized Model No.	Carton Quantity
3/8 x 12	ATR3/8x12	—	—	1
3/8 x 24	ATR3/8x24	—	—	1
3/8 x 36	ATR3/8x36	—	ATR3/8x36HDG	1
1/2 x 12	ATR1/2x12	ATR1/2x12ZP	ATR1/2x12HDG	1
1/2 x 18	ATR1/2x18	—	ATR1/2x18HDG	1
1/2 x 24	ATR1/2x24	ATR1/2x24ZP	ATR1/2x24HDG	1
1/2 x 36	ATR1/2x36	ATR1/2x36ZP	ATR1/2x36HDG	1
5/8 x 12	ATR5/8x12	ATR5/8x12ZP	ATR5/8x12HDG	1
5/8 x 18	ATR5/8x18	ATR5/8x18ZP	ATR5/8x18HDG	1
5/8 x 24	ATR5/8x24	ATR5/8x24ZP	ATR5/8x24HDG	1
5/8 x 30	ATR5/8x30	—	—	1
5/8 x 36	ATR5/8x36	ATR5/8x36ZP	ATR5/8x36HDG	1
3/4 x 12	ATR3/4x12	ATR3/4x12ZP	ATR3/4x12HDG	1
3/4 x 18	ATR3/4x18	ATR3/4x18ZP	ATR3/4x18HDG	1
3/4 x 24	ATR3/4x24	ATR3/4x24ZP	ATR3/4x24HDG	1
3/4 x 36	ATR3/4x36	ATR3/4x36ZP	ATR3/4x36HDG	1
7/8 x 12	ATR7/8x12	ATR7/8x12ZP	ATR7/8x12HDG	1
7/8 x 18	ATR7/8x18	ATR7/8x18ZP	ATR7/8x18HDG	1
7/8 x 20	ATR7/8x20	—	—	1
7/8 x 24	ATR7/8x24	ATR7/8x24ZP	ATR7/8x24HDG	1
7/8 x 26	ATR7/8x26	—	—	1
7/8 x 36	ATR7/8x36	ATR7/8x36ZP	ATR7/8x36HDG	1
1 x 12	ATR1x12	ATR1x12ZP	ATR1x12HDG	1
1 x 18	ATR1x18	ATR1x18ZP	ATR1x18HDG	1
1 x 24	ATR1x24	ATR1x24ZP	ATR1x24HDG	1
1 x 36	ATR1x36	ATR1x36ZP	ATR1x36HDG	1

Adhesive Anchoring Installation Instructions



NOTE: Always check expiration date on product label. Do not use expired product.



WARNING: When drilling and cleaning hole, use eye and lung protection. When installing adhesive, use eye and skin protection.

1A Hole Preparation — Horizontal, Vertical and Overhead Applications (SET-3G™ for anchor installation)

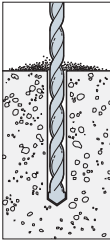

1. Drill.
Drill hole to specified diameter and depth.

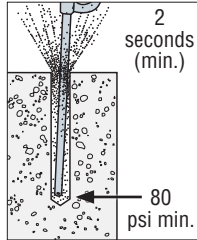

2. Blow.
Remove dust from hole with oil-free compressed air for a minimum of two seconds. Compressed air nozzle must reach the bottom of the hole.

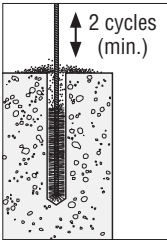

3. Brush.
Clean with a steel wire brush for a minimum of two cycles. Brush should provide resistance to insertion. If no resistance is felt, the brush is worn and must be replaced.

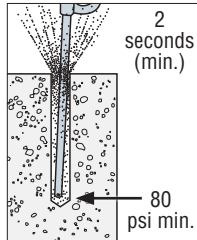

4. Blow.
Remove dust from hole with oil-free compressed air for a minimum of two seconds. Compressed air nozzle must reach the bottom of the hole.

Visit strongtie.com for proper brush part number.

Hole Preparation — Horizontal, Vertical and Overhead Applications (SET-XP®, AT-XP®, ET-HP®) and (SET-3G only for post-installed rebar connections)

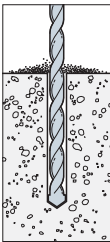

1. Drill.
Drill hole to specified diameter and depth.

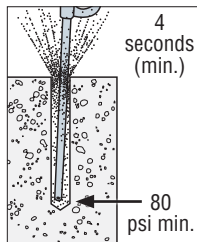

2. Blow.
Remove dust from hole with oil-free compressed air for a minimum of four seconds. Compressed air nozzle must reach the bottom of the hole.

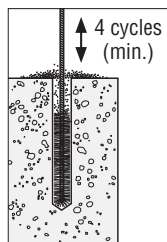

3. Brush.
Clean with a nylon brush for a minimum of four cycles. Brush should provide resistance to insertion. If no resistance is felt, the brush is worn and must be replaced.

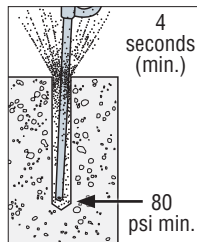

4. Blow.
Remove dust from hole with oil-free compressed air for a minimum of four seconds. Compressed air nozzle must reach the bottom of the hole.

Visit strongtie.com for proper brush part number.

Adhesive Anchoring Installation Instructions

1B Hole Preparation Vacuum Drill Bit System* —

Horizontal, Vertical and Overhead Applications

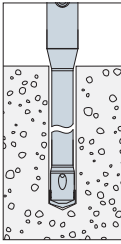
**1. Drill.**

Drill hole to specified diameter and depth using the accepted vacuum drill bit system.*



Approved for installation with multiple vacuum drill bit systems.*

*Note: Visit strongtie.com for tested and accepted hollow carbide drill bit and vacuum dust extraction systems.

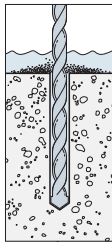
1C Hole Preparation — Submerged Applications (SET-3G™ only)**1. Drill.**

Drill hole to specified diameter and depth.

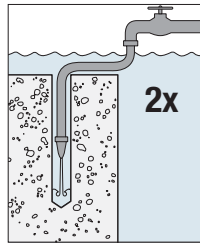
**2. Flush.**

Remove slurry from hole by flushing hole twice with water until water runs clear.

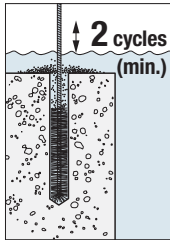
**3. Brush.**

Clean with a steel wire brush for a minimum of two cycles. Brush should provide resistance to insertion. If no resistance is felt, the brush is worn and must be replaced.

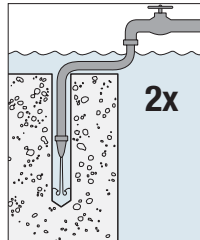
**4. Flush.**

Remove slurry from hole by flushing hole twice with water until water runs clear.

Visit strongtie.com for proper brush part number.

Adhesive Anchoring Installation Instructions

2 Cartridge Preparation**1. Check.**

Check expiration date on product label. Product is usable until end of printed expiration month. **Do not use expired product.**

2. Open.

Open cartridge per package instructions.

3. Attach.

Attach proper Simpson Strong-Tie® nozzle and extension to cartridge. Do not modify nozzle.

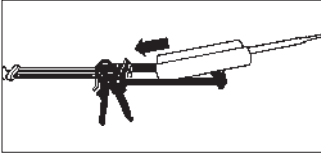
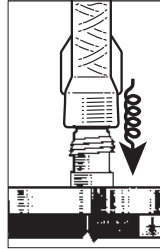
**4. Insert.**

Insert cartridge into dispensing tool.

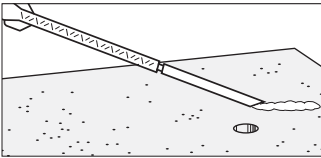
**5. Dispense.**

Dispense adhesive to the side until properly mixed (uniform color).

Adhesive Anchoring Installation Instructions

3A Filling the Hole — Vertical Anchorage

Prepare the hole per “Hole Preparation” instructions on product label.

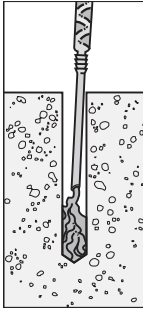
Dry and Damp Holes:**1. Fill.**

Fill hole $\frac{1}{2}$ to $\frac{2}{3}$ full, starting from bottom of hole to prevent air pockets. Withdraw nozzle as hole fills up.

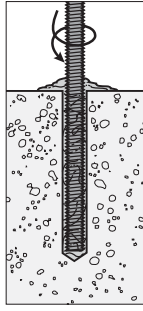
**2. Insert.**

Insert clean, oil-free anchor, (marked with the required embedment depth), turning slowly until the anchor contacts the bottom of the hole.

Threaded rod or rebar

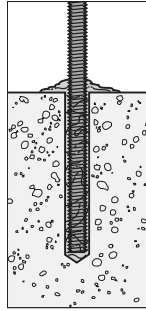
**3. Do not disturb.**

Do not disturb load or torque anchor until fully cured.

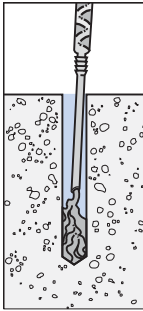
Water-Filled Holes:**1. Fill.**

Fill hole completely full, starting from bottom of hole to prevent water pockets. Withdraw nozzle as hole fills up.

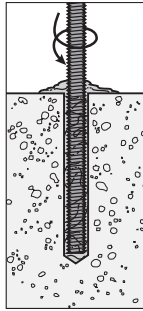
**2. Insert.**

Insert clean, oil-free anchor, (marked with the required embedment depth), turning slowly until the anchor contacts the bottom of the hole.

Threaded rod or rebar

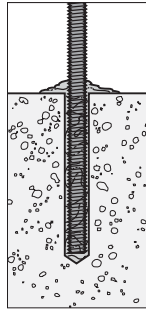
**3. Do not disturb.**

Do not disturb load or torque anchor until fully cured.

Note: Nozzle extensions may be needed for deep holes.

Adhesive Anchoring Installation Instructions

3B Filling the Hole — Horizontal and Overhead Anchorage

Prepare the hole per "Hole Preparation" instructions on product label.

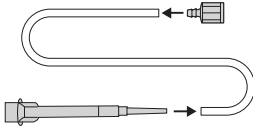
**Step 1**

- Attach the piston plug to one end of the flexible tubing (PPFT25).
- Cut tubing to the length needed for the application, mark tubing as noted below and attach other end of tubing to the mixing nozzle.
- If using a pneumatic dispensing tool, regulate air pressure to 80–100 psi.

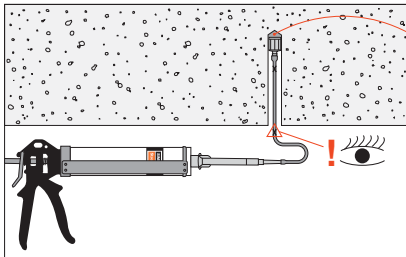
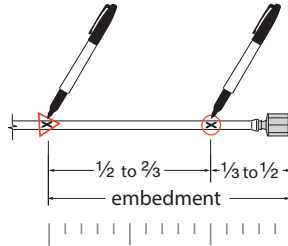
**Step 2**

- Insert the piston plug to the back of the drilled hole and dispense adhesive.

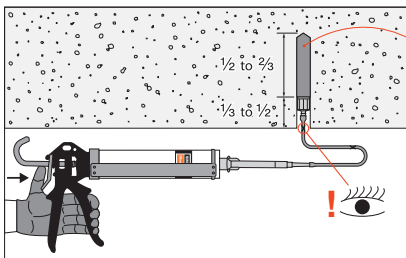
**Step 3**

- Fill the hole $\frac{1}{2}$ to $\frac{2}{3}$ full.

Note: As adhesive is dispensed into the drilled hole, the piston plug will slowly displace out of the hole due to back pressure, preventing air gaps.

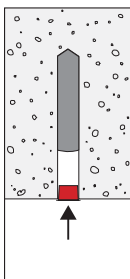
**Step 4**

- Install the appropriate Simpson Strong-Tie® adhesive retaining cap.

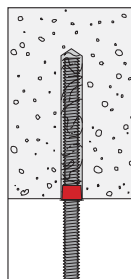
**Step 5**

- Place either threaded rod or rebar through the adhesive retaining cap and into adhesive filled hole.
- Turn rod/rebar (marked with the required embedment depth) slowly until the insert bottoms out.
- Do not disturb load or torque anchor until fully cured. For overhead installations, the anchor must be secured from movement during the cure time (e.g., wedges or other restraint methods).

Adhesive Anchoring Installation Instructions

- 3C Filling the Hole** – Submerged Anchorage (SET-3G™ only)
Prepare the hole per “Hole Preparation” instructions on product label.

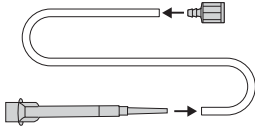
**Step 1**

- Attach the piston plug to one end of the flexible tubing (PPFT25).
- Cut tubing to the length needed for the application, mark tubing as noted below and attach other end of tubing to the mixing nozzle.
- If using a pneumatic dispensing tool, regulate air pressure to 80–100 psi.

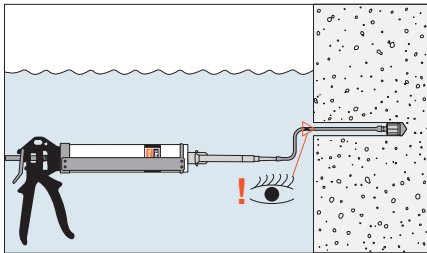
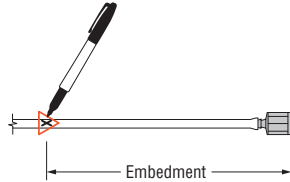
**Step 2**

- Insert the piston plug to the back of the drilled hole and dispense adhesive.

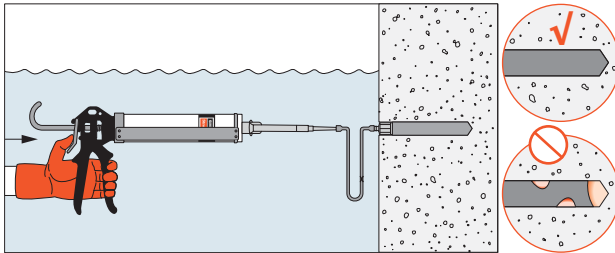
**Step 3**

- Fill the hole completely full.

Note: As adhesive is dispensed into the drilled hole, the piston plug will slowly displace out of the hole due to back pressure, preventing air gaps.

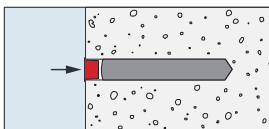
**Step 4**

- Install the appropriate Simpson Strong-Tie adhesive retaining cap.

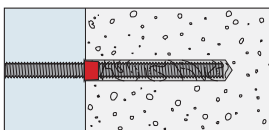
**Step 5**

- Place either threaded rod or rebar through the adhesive retaining cap and into adhesive filled hole.
- Turn rod/rebar (marked with the required embedment depth) slowly until the insert bottoms out.
- Do not disturb load or torque anchor until fully cured.

Adhesive Anchoring Installation Instructions

FOR HOLLOW BASE MATERIALS

3D Filling the Hole —

When Anchoring with Screens: For SET-3G™, SET-XP® and AT-XP® Adhesives

Prepare the hole per instructions on “Hole Preparation.”

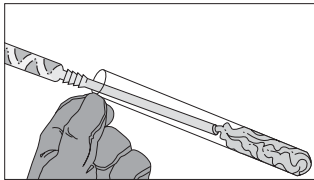
**1. Fill.**

Fill screen completely. Fill from the bottom of the screen and withdraw the nozzle as the screen fills to prevent air pockets. (Close integral cap after filling.)

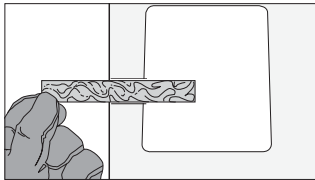
**2. Insert.**

Insert adhesive-filled screen into hole.

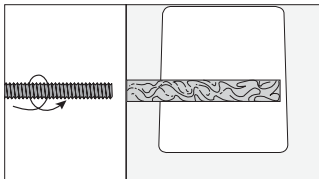
**3. Insert.**

Insert clean, oil-free anchor, turning slowly until the anchor contacts the bottom of the screen.

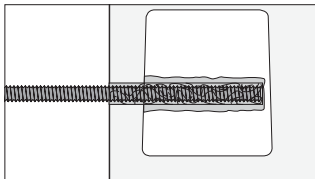
**4. Do not disturb.**

Do not disturb anchor until fully cured. (See cure schedule for specific adhesive.)

FOR UNREINFORCED BRICK MASONRY

1A Hole Preparation —

For Configurations A (Horizontal) and B (22½° Downward)

Installations with a Carbide-Tipped Drill Bit.

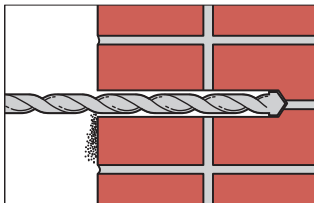
**1. Drill.**

Drill 1"-diameter hole to specified depth with a carbide-tipped drill bit, using rotation only mode. For Configurations A, drill 8" deep. For Configuration B, drill to within 1" of the opposite side of wall (minimum 13" deep).

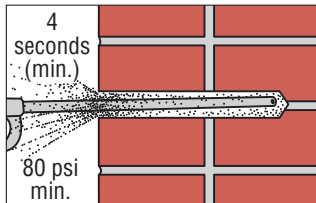
**2. Blow.**

Remove dust from hole with oil-free compressed air for a minimum of four seconds. Compressed air nozzle **MUST** reach the bottom of the hole.

Adhesive Anchoring Installation Instructions

FOR UNREINFORCED BRICK MASONRY (cont.)

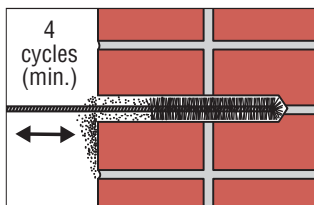
**3. Brush.**

Clean with a nylon brush for a minimum of four cycles. Brush **MUST** reach the bottom of the hole. Brush should provide resistance to insertion. If no resistance is felt, the brush is worn and must be replaced.

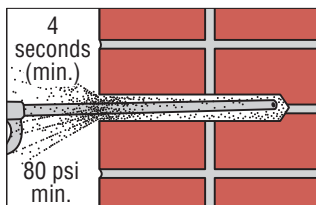
**4. Blow.**

Remove dust from hole with oil-free compressed air for a minimum of four seconds. Compressed air nozzle **MUST** reach the bottom of the hole.

2 Cartridge Preparation

Reference p. 44 for cartridge preparation.

3 Filling the Hole –

For Configurations A (Horizontal) and B (22½° Downward) Installations.

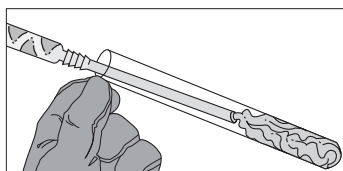
**1. Fill.**

Fill screen completely. Fill from the bottom of the screen and withdraw the nozzle as the screen fills to prevent air pockets.

**2. Insert.**

Insert adhesive filled screen into hole.

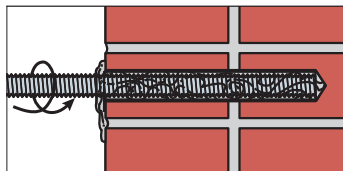
**3. Insert.**

Insert clean, oil-free anchor, turning slowly until the anchor contacts the bottom of the screen.

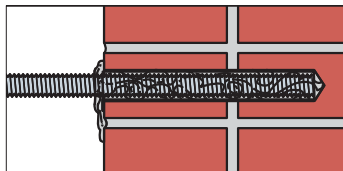
**4. Do not disturb.**

Do not disturb anchor until fully cured. (See cure schedule for specific adhesive.)

Note: Steel wire mesh screens may be used for Configurations A and B.



Mechanical Anchors



Titen HD® Heavy-Duty Screw Anchor

A high-strength screw anchor for use in cracked and uncracked concrete, as well as uncracked masonry. The Titen HD offers low installation torque and outstanding performance. Suitable in dry, interior, non-corrosive environments or temporary outdoor applications.



Features

- Qualified for static and seismic loading conditions
- Thread design undercuts to efficiently transfer the load to the base material
- Standard fractional sizes
- Specialized heat-treating process creates tip hardness for better cutting without compromising the ductility
- No special drill bit required — designed to install using standard-sized ANSI tolerance drill bits
- Hex-washer head requires no separate washer, unless required by code, and provides a clean installed appearance
- Removable — ideal for temporary anchoring (e.g., formwork, bracing) or applications where fixtures may need to be moved
- Reuse of the anchor will not achieve listed loads and is not recommended

Codes: ICC-ES ESR-2713 (concrete); ICC-ES ESR-1056 (masonry); City of LA Supplement within ESR-2713 (concrete); City of LA Supplement within ESR-1056 (masonry); Florida FL15730 (concrete and masonry); FM 3017082, 3035761 and 3043442; multiple DOT listings

Material: Carbon steel

Coating: Zinc plated or mechanically galvanized. Not recommended for permanent exterior use or highly corrosive environments.

Installation

 Holes in metal fixtures to be mounted should match the diameter specified in the table on p. 53. Use a Titen HD screw anchor one time only — installing the anchor multiple times may result in excessive thread wear and reduce load capacity.

 Do not use impact wrenches to install into hollow CMU.

 **Caution:** Oversized holes in base material will reduce or eliminate the mechanical interlock of the threads with the base material and reduce the anchor's load capacity.

1. Drill a hole in the base material using a carbide drill bit the same diameter as the nominal diameter of the anchor to be installed. Drill the hole to the specified embedment depth plus minimum hole depth overall (see table on p. 53) to allow the thread tapping dust to settle, and blow it clean using compressed air. (Overhead installations need not be blown clean.) Alternatively, drill the hole deep enough to accommodate embedment depth and the dust from drilling and tapping.
2. Insert the anchor through the fixture and into the hole.
3. Tighten the anchor into the base material until the hex-washer head contacts the fixture.



Titen HD
Screw Anchor



Serrated teeth on the tip of the Titen HD screw anchor facilitate cutting and reduce installation torque.

Titen HD® Heavy-Duty Screw Anchor

Installation Sequence

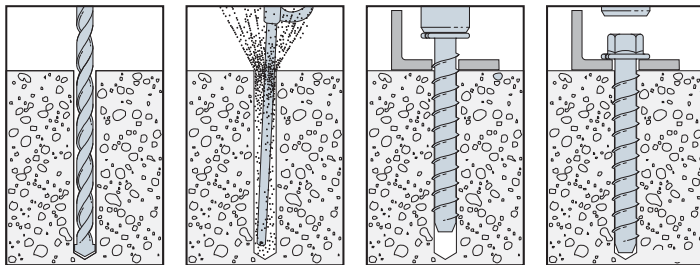

Additional Installation Information for Structural Steel

Titen HD Diameter (in.)	Wrench Size (in.)	Recommended Steel Fixture Hole Size (in.)	Minimum Hole Depth Overdrill (in.)
1/4	3/8	3/8 to 7/16	1/8
3/8	9/16	1/2 to 9/16	1/4
1/2	3/4	5/8 to 11/16	1/2
5/8	15/16	3/4 to 13/16	1/2
3/4	1 1/8	7/8 to 15/16	1/2

Suggested fixture hole sizes are for structural steel thicker than 12 gauge only. Larger holes are not required for wood or cold-formed steel members.

Titen HD Anchor Product Data — Mechanically Galvanized

Size (in.)	Model No.	Thread Length (in.)	Drill Bit Diameter (in.)	Wrench Size (in.)	Quantity	
					Box	Carton
3/8 x 3	THD37300HMG	2 1/2	3/8	9/16	50	200
3/8 x 4	THD37400HMG	3 1/2			50	200
3/8 x 5	THD37500HMG	4 1/2			50	100
3/8 x 6	THD37600HMG	5 1/2			50	100
1/2 x 4	THD50400HMG	3 1/2	1/2	3/4	20	80
1/2 x 5	THD50500HMG	4 1/2			20	80
1/2 x 6	THD50600HMG	5 1/2			20	80
1/2 x 6 1/2	THD50612HMG	5 1/2			20	40
1/2 x 8	THD50800HMG	5 1/2			20	40
1/2 x 12	THD501200HMG	5 1/2			5	20
5/8 x 5	THDB62500HMG	4 1/2	5/8	15/16	10	40
5/8 x 6	THDB62600HMG	5 1/2			10	40
5/8 x 6 1/2	THDB62612HMG	5 1/2			10	40
5/8 x 8	THDB62800HMG	5 1/2			10	20
3/4 x 5	THD75500HMG	4 1/2	3/4	1 1/8	5	20
3/4 x 6	THDT75600HMG	4 1/2			5	20
3/4 x 8 1/2	THD75812HMG	5 1/2			5	10
3/4 x 10	THD75100HMG	5 1/2			5	10

Mechanical galvanizing meets ASTM B695, Class 65, Type 1. Intended for some pressure-treated wood sill plate applications. Not for use in other corrosive or outdoor environments. Visit strongtie.com/info for more corrosion information.

Titen HD® Heavy-Duty Screw Anchor

Countersunk Head Style

The countersunk head style is for applications that require a flush-mount profile. Countersinking also leaves a cleaner surface appearance for exposed through-set applications. The anchor head's 6-lobe drive eases installation and is less prone to stripping than traditional recessed anchor heads.

Features

- Available in many standard lengths in $\frac{1}{4}$ " and $\frac{3}{8}$ " diameters
- Driver bit included in each box

Codes: ICC-ES ESR-2713 (concrete);
ICC-ES ESR-1056 (masonry);
City of LA Supplement within ESR-2713 (concrete);
City of LA Supplement within ESR-1056 (masonry);
Florida FL15730 (concrete and masonry)

Material: Carbon steel

Coating: Zinc plated

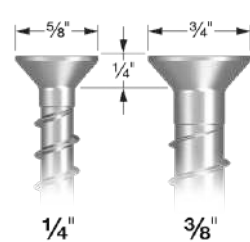

6-lobe drive

Titen HD
Countersunk
Head Style

Additional Installation Information

Titen HD Diameter (in.)	Bit Size	Recommended Steel Fixture Hole Size (in.)	Minimum Hole Depth Overdrill (in.)
$\frac{1}{4}$	T30	$\frac{3}{8}$ to $\frac{7}{16}$	$\frac{1}{8}$
$\frac{3}{8}$	T50	$\frac{1}{2}$ to $\frac{9}{16}$	$\frac{1}{4}$

Suggested fixture hole sizes are for structural steel thicker than 12 gauge only. Larger holes are not required for wood or thinner cold-formed steel members.

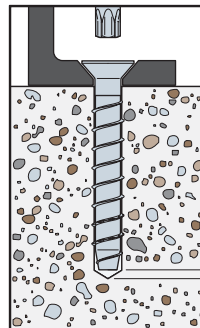

Minimum overdrill.
See table.

Titen HD® Heavy-Duty Screw Anchor

Washer-Head Head Style

The washer-head design is commonly used where a minimal head profile is necessary. The model is offered in sizes suitable for use in sill plate applications, and the washer head's low installed profile means modular wall and floor systems can be installed on top with no need for notching the wall framing to accommodate the anchor. The anchor's 6-lobe drive eases driving and is less prone to stripping.

Features

- Available in many standard lengths in $\frac{1}{2}$ " and $\frac{5}{8}$ " diameters
- Driver bit included in each box

Codes: ICC-ES ESR-2713 (concrete);
City of LA Supplement within ESR-2713 (concrete);
Florida FL15730 (concrete)

Material: Carbon steel

Coating: Zinc plated

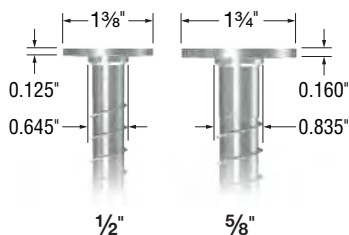

6-lobe drive

Titen HD
Washer-Head
Head Style

Additional Installation Information

Titen HD Diameter (in.)	Bit Size	Recommended Steel Fixture Hole Size ^{1,2} (in.)	Minimum Hole Depth Overdrill (in.)
$\frac{1}{2}$	T50	$\frac{5}{8}$ to $1\frac{1}{16}$	$\frac{1}{2}$
$\frac{5}{8}$	T60	$\frac{3}{4}$ to $1\frac{3}{16}$	$\frac{1}{2}$

1. For anchor threads to clear, fixture hole sizes are suggested for installation through structural steel thicker than 12 gauge. Larger holes are not required for wood or thinner cold-formed steel members.
2. In order for washer head to seat against steel fixture, larger fixture hole may be required to accommodate collar underneath washer head. See the figure above for collar dimensions.

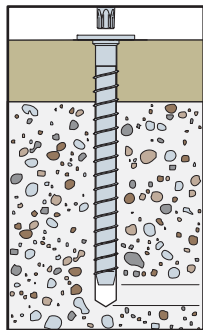

Minimum overdrill.
See table.

Titen HD® Heavy-Duty Screw Anchor

Titen HD Anchor Product Data — Zinc Plated¹

Size (in.)	Model No.	Thread Length (in.)	Drill Bit Diameter (in.)	Wrench Size (in.)	Quantity	
					Box	Carton
¼ x 1 7/8	THDB25178H	1 ½	¼	¾	100	500
¼ x 2 ¾	THDB25234H	2 ¾	¼	¾	50	250
¼ x 3	THDB25300H	2 ¾	¼	¾	50	250
¼ x 3 ½	THDB25312H	3 ½	¼	¾	50	250
¼ x 4	THDB25400H	3 ¾	¼	¾	50	250
¾ x 1 ¾	THD37134H ^{2,3}	1 ¼	¾	9/16	50	250
¾ x 2 ½	THD37212H ^{2,3}	2	¾	9/16	50	200
¾ x 3	THD37300H	2 ½	¾	9/16	50	200
¾ x 4	THD37400H	3 ½	¾	9/16	50	200
¾ x 5	THD37500H	4 ½	¾	9/16	50	100
¾ x 6	THD37600H	5 ½	¾	9/16	50	100
½ x 3	THD50300H ^{2,4}	2 ½	½	¾	25	100
½ x 4	THD50400H	3 ½	½	¾	20	80
½ x 5	THD50500H	4 ½	½	¾	20	80
½ x 6	THD50600H	5 ½	½	¾	20	80
½ x 6 ½	THD50612H	5 ½	½	¾	20	40
½ x 8	THD50800H	5 ½	½	¾	20	40
½ x 12	THD501200H	5 ½	½	¾	5	25
½ x 13	THD501300H	5 ½	½	¾	5	25
½ x 14	THD501400H	5 ½	½	¾	5	25
½ x 15	THD501500H	5 ½	½	¾	5	25
⅝ x 4	THDB62400H ^{2,4}	3 ½	⅝	1 5/16	10	40
⅝ x 5	THDB62500H	4 ½	⅝	1 5/16	10	40
⅝ x 6	THDB62600H	5 ½	⅝	1 5/16	10	40
⅝ x 6 ½	THDB62612H	5 ½	⅝	1 5/16	10	40
⅝ x 8	THDB62800H	5 ½	⅝	1 5/16	10	20
⅝ x 10	THDB62100H	5 ½	⅝	1 5/16	10	20
¾ x 4	THD75400H ^{2,5}	3 ½	¾	1 ½	10	40
¾ x 5	THD75500H	4 ½	¾	1 ½	5	20
¾ x 6	THDT75600H	4 ½	¾	1 ½	5	20
¾ x 7	THD75700H	5 ½	¾	1 ½	5	10
¾ x 8 ½	THD75812H	5 ½	¾	1 ½	5	10
¾ x 10	THD75100H	5 ½	¾	1 ½	5	10

- Length of anchor is measured from underside of head to end of anchor.
- These models do not meet minimum embedment depth requirements for strength design.
- Installation torque shall not exceed 25 ft.-lb. using a manual torque wrench or maximum torque rating of 100 ft.-lb. when installed with impact wrench.
- Installation torque shall not exceed 50 ft.-lb. using a manual torque wrench or maximum torque rating of 100 ft.-lb. when installed with impact wrench.
- Installation torque shall not exceed 50 ft.-lb. using a manual torque wrench or maximum torque rating of 135 ft.-lb. when installed with impact wrench.



THDT75600H



THD75700H

Titen HD® Heavy-Duty Screw Anchor





Titen HD Anchor Product Data — Countersunk — Zinc Plated

Size (in.)	Model No.	Thread Length (in.)	Drill Bit Diameter (in.)	Wrench Size (in.)	Quantity	
					Box	Carton
¼ x 1½	THDB25178CS	1½	¼	T30	100	500
¼ x 2¾	THDB25234CS	2¾	¼	T30	50	250
¼ x 3½	THDB25312CS	3½	¼	T30	50	250
¼ x 4½	THDB25412CS	4½	¼	T30	50	250
⅜ x 2½	THD37212CS [†]	2	⅜	T50	50	200
⅜ x 3	THD37300CS	2½	⅜	T50	50	200
⅜ x 4	THD37400CS	3½	⅜	T50	50	200
⅜ x 5	THD37500CS	4½	⅜	T50	50	100

† This model does not meet minimum embedment depth requirements for strength design and require maximum installation torque of 25 ft.-lb. using a torque wrench, driver drill or cordless ¼" impact driver with a maximum permitted torque rating of 100 ft.-lb.

1. Length of anchor is measured from top of head to bottom of anchor.

Titen HD Anchor Product Data — Washer Head — Zinc Plated

Size (in.)	Model No.	Thread Length (in.)	Drill Bit Diameter (in.)	Bit Size	Quantity	
					Box	Carton
 ½ x 6	THD50600WH	5½	½	T50	15	60
 ½ x 8	THD50800WH	5½	½	T50	15	30
 ⅝ x 6	THDB62600WH	5½	⅝	T60	10	40
 ⅝ x 8	THDB62800WH	5½	⅝	T60	10	20
 ⅝ x 10	THDB62100WH	5½	⅝	T60	10	20

1. Length of anchor is measured from underside of head to bottom of anchor.

Stainless-Steel Titen HD® Heavy-Duty Screw Anchor

The Titen HD stainless-steel screw anchor for concrete and masonry sets the standard for when the job calls for installation in multiple types of environments. It is the ultimate choice to provide fast and efficient installation, combined with long-lasting corrosion resistance for an unsurpassed peace-of-mind.

Innovative — The serrated carbon-steel threads on the tip of the stainless-steel Titen HD are vital because they undercut the concrete as the anchor is driven into the hole, making way for the rest of the threads to interlock with the concrete.

Corrosion Resistant — Type 304SS has very good corrosion resistance for general exterior environments and those where chemicals such as fertilizers, soil and acid rain are present. Type 316SS has the maximum corrosion resistance for severe environments, such as marine and seaside applications. It is resistant to chlorine, chlorides (salt), sulfuric acids and a wide range of chemicals.



Features

- Ideal for exterior or corrosive environments
- Less carbon steel, less expansion
- An extensive variety of sizes offered; along with several different material types to match your installation needs

Codes: IAPMO UES ER-493 (concrete);
ICC-ES ESR-1056 (masonry);
City of LA Supplement within ER-493 (concrete);
City of LA Supplement within ESR-1056 (masonry);
Florida FL15730 (masonry); FL16230 (concrete)

Material: Type 316 and Type 304 stainless steel with carbon-steel lead threads

Installation

-  **Caution:** Holes in steel fixtures to be mounted should match the diameter specified in the table on p. 59 if steel is thicker than 12 gauge.
-  **Caution:** Use a Titen HD screw anchor one time only — installing the anchor multiple times may result in excessive thread wear and reduce load capacity.
Do not use impact wrenches to install into hollow CMU.
-  **Caution:** Oversized holes in base material will reduce or eliminate the mechanical interlock of the threads with the base material and reduce the anchor's load capacity.
1. Drill a hole in the base material using a carbide drill bit (complying with ANSI B212.15) with the same diameter as the nominal diameter of the anchor to be installed. Drill the hole to the specified minimum hole depth overdrill (see table on p. 59) to allow the thread tapping dust to settle, and blow it clean using compressed air. (Overhead installations need not be blown clean.) Alternatively, drill the hole deep enough to accommodate embedment depth and the dust from drilling and tapping.
 2. Insert the anchor through the fixture and into the hole.
 3. Tighten the anchor into the base material until the hex-washer head contacts the fixture.



Stainless-Steel
Titen HD
Screw Anchor

US Patents: 8,747,042 B2
and 9,517,519



Innovative carbon-steel thread effectively cuts the concrete while significantly limiting the amount of carbon steel in the anchor, minimizing the amount of corrosion potential that can occur in an exterior corrosive environment.

Stainless-Steel Titen HD® Heavy-Duty Screw Anchor

Installation Sequence

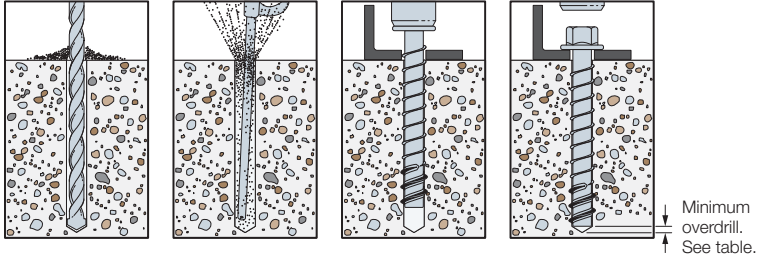

Additional Installation Information

Titen HD® Diameter (in.)	Wrench Size (in.)	Recommended Steel Fixture Hole Size (in.)	Minimum Hole Depth Overdrill (in.)
1/4	3/8	3/8 to 7/16	1/8
3/8	9/16	1/2 to 9/16	1/4
1/2	3/4	5/8 to 11/16	1/2
5/8	15/16	3/4 to 13/16	1/2
3/4	1 1/8	7/8 to 15/16	1/2

Suggested fixture hole sizes are for structural steel thicker than 12 gauge only. Larger holes are not required for wood or cold-formed steel members.

Stainless-Steel Titen HD Anchor Product Data — Hex Washer Head

Size (in.)	Model No. (Type 316)	Model No. (Type 304)	Thread Length (in.)	Drill Bit Diameter (in.)	Wrench Size (in.)	Quantity	
						Box	Carton
1/4 x 2	THDC25200H6SS [†]	—	1 1/8	1/4	3/8	50	250
1/4 x 2 3/8	THDC25238H6SS	—	2 1/4	1/4	3/8	50	250
1/4 x 3	THDC25300H6SS	—	2 7/8	1/4	3/8	50	250
1/4 x 4	THDC25400H6SS	—	3 3/8	1/4	3/8	50	250
3/8 x 3	THD37300H6SS	THD37300H4SS	2 1/2	3/8	9/16	50	200
3/8 x 4	THD37400H6SS	THD37400H4SS	3 1/2	3/8	9/16	50	200
3/8 x 5	THD37500H6SS	THD37500H4SS	4 1/2	3/8	9/16	50	100
3/8 x 6	THD37600H6SS	THD37600H4SS	5 1/2	3/8	9/16	50	100
1/2 x 3	THD50300H6SS [†]	THD50300H4SS [†]	2 1/2	1/2	3/4	25	100
1/2 x 4	THD50400H6SS	THD50400H4SS	3 1/2	1/2	3/4	20	80
1/2 x 5	THD50500H6SS	THD50500H4SS	4 1/2	1/2	3/4	20	80
1/2 x 6	THD50600H6SS	THD50600H4SS	5 1/2	1/2	3/4	20	80
1/2 x 6 1/2	THD50612H6SS	THD50612H4SS	6	1/2	3/4	20	40
1/2 x 8	THD50800H6SS	THD50800H4SS	6 7/8	1/2	3/4	20	40
5/8 x 4	THDB62400H6SS [†]	THDB62400H4SS [†]	3 1/2	5/8	15/16	10	40
5/8 x 5	THDB62500H6SS	THDB62500H4SS	4 1/2	5/8	15/16	10	40
5/8 x 6	THDB62600H6SS	THDB62600H4SS	5 1/2	5/8	15/16	10	40
5/8 x 6 1/2	THDB62612H6SS	THDB62612H4SS	6	5/8	15/16	10	40
5/8 x 8	THDB62800H6SS	THDB62800H4SS	7 1/16	5/8	15/16	10	20
3/4 x 4	THD75400H6SS [†]	THD75400H4SS [†]	3 1/2	3/4	1 1/8	10	40
3/4 x 5	THD75500H6SS [†]	THD75500H4SS [†]	4 1/2	3/4	1 1/8	5	20
3/4 x 6	THD75600H6SS	THD75600H4SS	5 1/2	3/4	1 1/8	5	20
3/4 x 7	THD75700H6SS	THD75700H4SS	6 1/2	3/4	1 1/8	5	10
3/4 x 8 1/2	THD75812H6SS	THD75812H4SS	7 3/16	3/4	1 1/8	5	10

[†] Does not meet minimum embedment in code report.

1. Anchor length is measured from under head to bottom of anchor.

Stainless-Steel Titen HD® Heavy-Duty Screw Anchor

Stainless-Steel Countersunk Head Style

The countersunk head style is for applications that require a flush-mount profile. Countersinking also leaves a cleaner surface appearance for exposed through-set applications. The anchor head's 6-lobe drive eases installation and is less prone to stripping than traditional recessed anchor heads.

Features

- Available in many standard lengths in $\frac{1}{4}$ " and $\frac{3}{8}$ " diameters
- Countersunk head allows screw anchor applications incompatible with a hex head
- Driver bit included in each box

Codes: IAPMO UES ER-493 (concrete); ICC-ES ESR-1056 (masonry); City of LA Supplement within ER-493 (concrete); City of LA Supplement within ESR-1056 (masonry); Florida FL15730 (masonry); FL16230 (concrete)

Material: Type 316 stainless steel with carbon-steel lead threads

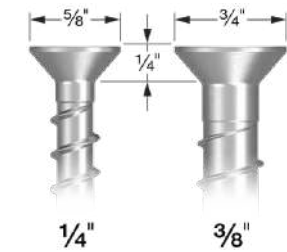

6-lobe drive



Stainless-Steel Titen HD Countersunk Head Style Screw Anchor

Additional Installation Information

Titen HD Diameter (in.)	Bit Size	Recommended Steel Fixture Hole Size (in.)	Minimum Hole Depth Overdrill (in.)
$\frac{1}{4}$	T30	$\frac{3}{8}$ to $\frac{7}{16}$	$\frac{1}{8}$
$\frac{3}{8}$	T50	$\frac{1}{2}$ to $\frac{9}{16}$	$\frac{1}{4}$

Suggested fixture hole sizes are for structural steel thicker than 12 gauge only. Larger holes are not required for wood or thinner cold-formed steel members.

Stainless-Steel Titen HD® Heavy-Duty Screw Anchor

Installation Sequence

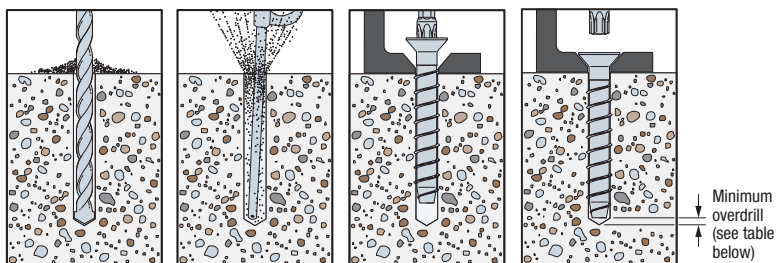

Stainless-Steel Titen HD Anchor Product Data — Countersunk Head

Size (in.)	Model No. (Type 316)	Thread Length (in.)	Drill Bit Diameter (in.)	Wrench Size (in.)	Quantity	
					Box	Carton
1/4 x 2 3/8	THDC25238CS6SS†	2	1/4	T30	25	250
1/4 x 3	THDC25300CS6SS	2 5/8	1/4	T30	25	250
1/4 x 4	THDC25400CS6SS	3 5/8	1/4	T30	25	250
3/8 x 2 1/2	THD37212CS6SS†	2	3/8	T50	25	125
3/8 x 3	THD37300CS6SS	2 1/2	3/8	T50	25	125
3/8 x 4	THD37400CS6SS	3 1/2	3/8	T50	25	125

† These models do not meet minimum embedment depth requirements for strength design and require maximum installation torque of 25 ft.-lb. using a torque wrench, driver drill or cordless 1/4" impact driver with a maximum permitted torque rating of 100 ft.-lb.

1. Anchor length is measured from top of head to bottom of anchor.

For additional load information, see strongtie.com.

Titen HD® Rod Coupler

The Titen HD rod coupler is designed to be used in conjunction with a single or multi-story rod tiedown system. This anchor provides a fast and simple way to attach threaded rod to a concrete stem wall or thickened slab footing. Unlike adhesive anchors, the installation requires no special tools, cure time or secondary setting process; just drill a hole and drive the anchor.

Features

- The serrated cutting teeth and patented thread design enable the Titen HD rod coupler to be installed quickly and easily. Less installation time translates to lower installed cost.
- The specialized heat treating process creates tip hardness to facilitate cutting while the body remain ductile.
- No special setting tools required. ANSI size bits and standard sockets.
- Compatible with threaded rods in $\frac{3}{8}$ " and $\frac{1}{2}$ " diameters.

Codes: ICC-ES ESR-2713 (concrete);
City of LA Supplement within ESR-2713 (concrete);
FL15730 (concrete)

Material: Carbon steel

Coating: Zinc plated

Installation



Caution: Oversized holes in the base material will reduce or eliminate the mechanical interlock of the threads with base material and will reduce the anchor's load capacity. Use a Titen HD Rod Coupler one time only. Installing the anchor multiple times may result in excessive thread wear and reduce load capacity.

1. Drill a hole using the specified diameter carbide bit into the base material to a depth of at least $\frac{1}{2}$ " deeper than the required embedment.
2. Blow the hole clean of dust and debris using compressed air. Overhead application need not be blown clean.
3. Tighten the anchor with appropriate size socket until the head sits flush against base material.



Titen HD
Rod Coupler

Titen HD® Rod Coupler

Installation Sequence

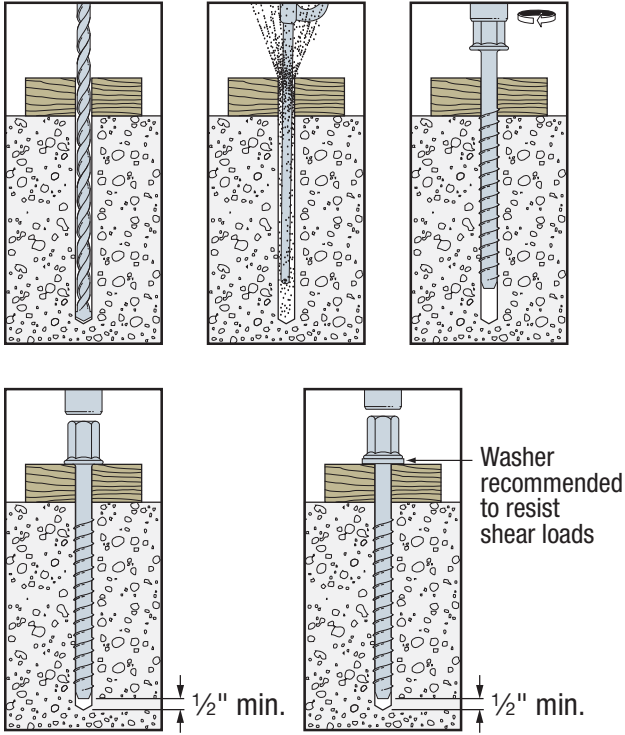

Titen HD Rod Coupler Product Data

Size (in)	Model No.	Accepts Rod Diameter (in.)	Drill Bit Diameter (in.)	Wrench Size (in.)	Quantity	
					Box	Carton
$\frac{3}{8}$ x $6\frac{3}{4}$	THD37634RC	$\frac{3}{8}$	$\frac{3}{8}$	$\frac{9}{16}$	25	50
$\frac{1}{2}$ x $9\frac{3}{4}$	THD50934RC	$\frac{1}{2}$	$\frac{1}{2}$	$\frac{3}{4}$	20	40

Strong-Bolt® 2 Wedge Anchor

Code listed for cracked and uncracked concrete, and masonry applications, the STB2 wedge-type expansion anchor is an optimal choice for high-performance even in seismic and high-wind conditions. Dual undercutting embossments on each clip segment enable secondary expansion should a crack form and intersect the anchor location; this feature significantly increases the ability of the STB2 to carry load if the hole expands. The STB2 has a chamfered top designed to prevent mushrooming during installation, and to ensure the nut can be easily installed/removed.

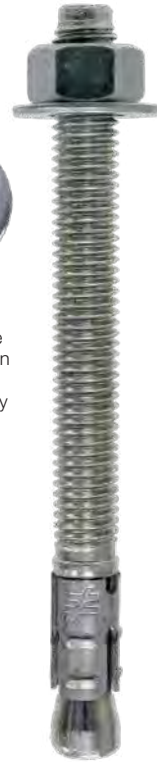
**Head Stamp**

The head is stamped with the length identification letter, bracketed top and bottom by horizontal lines.

Features

- Suitable for horizontal, vertical and overhead applications
- Qualified for minimum concrete thickness of 3¼", and lightweight concrete-over-metal deck thickness of 2½" and 3¼"
- Fits standard (ANSI) fixtures and installs with common drill bit and tool sizes

Codes: ICC-ES ESR-3037 (concrete); IAPMO UES ER-240 (carbon steel in CMU); City of LA Supplement within ESR-3037 (concrete); City of LA Supplement within ER-240 (carbon steel in CMU); Florida FL15730 (concrete); FL16230 (masonry); UL File Ex3605; FM 3043342 and 3047639; multiple DOT listings.

Meets the requirements of Federal Specifications A-A-1923A, Type 4.



Material: Zinc-plated carbon steel or stainless steel (Type 304; Type 316)

Material Specifications

Anchor Body	Nut	Washer	Clip
Carbon steel	Carbon steel, ASTM A 563, Grade A	Carbon steel ASTM F844	Carbon steel, ASTM A 568
Type 304 stainless steel	Type 304 stainless steel	Type 304 stainless steel	Type 304 or 316 stainless steel
Type 316 stainless steel	Type 316 stainless steel	Type 316 stainless steel	Type 316 stainless steel

Strong-Bolt® 2 Wedge Anchor

Installation

-  Do not use an impact wrench to set or tighten the Strong-Bolt 2 anchor.
-  **Caution:** Oversized holes in the base material will make it difficult to set the anchor and will reduce the anchor's load capacity.

1. Drill a hole in the base material using a carbide drill bit the same diameter as the nominal diameter of the anchor to be installed. Drill the hole to the specified minimum hole depth, and blow it clean using compressed air. (Overhead installations need not be blown clean.) Alternatively, drill the hole deep enough to accommodate embedment depth and dust from drilling.
2. Assemble the anchor with nut and washer so the top of the nut is flush with the top of the anchor. Place the anchor in the fixture, and drive it into the hole until the washer and nut are tight against the fixture.
3. Tighten to the required installation torque.

Installation Sequence

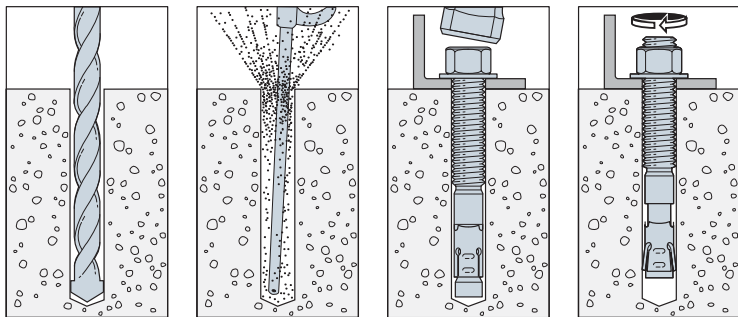

Strong-Bolt 2 Anchor Installation Data

Strong-Bolt 2 Diameter (in.)	1/4	3/8	1/2	5/8	3/4	1
Drill bit size (in.)	1/4	3/8	1/2	5/8	3/4	1
Min. fixture hole (in.)	5/16	7/16	9/16	11/16	7/8	1 1/8
Wrench size (in.)	7/16	9/16	3/4	15/16	1 1/8	1 1/2
Concrete installation torque (ft.-lbf.) Carbon steel	4	30	60	90	150	230
Concrete installation torque (ft.-lbf.) Stainless steel	4	30	65	80	150	—

For length identification head marks on Strong-Bolt 2 wedge anchor, see p. 210.

Strong-Bolt® 2 Wedge Anchor

Strong-Bolt 2 Anchor Product Data —
Carbon Steel and Mechanically Galvanized

Mechanical Anchors

Size (in.)	Carbon Steel Model No.	Mechanically Galvanized Model No.	Drill Bit Diameter (in.)	Thread Length (in.)	Quantity	
					Box	Carton
¼ x 1¾	STB2-25134	—	¼	1 5/16	100	500
¼ x 2¼	STB2-25214	—	¼	1 7/16	100	500
¼ x 3¼	STB2-25314	STB2-25314MG	¼	2 7/16	100	500
⅜ x 2¼	STB2-37214R50	—	⅜	1	50	250
⅜ x 2¾	STB2-37234	—	⅜	1 5/16	50	250
⅜ x 3	STB2-37300	STB2-37300MG	⅜	1 9/16	50	250
⅜ x 3½	STB2-37312	—	⅜	2 1/16	50	250
⅜ x 3¾	STB2-37334	STB2-37334MG	⅜	2 9/16	50	250
⅜ x 5	STB2-37500	STB2-37500MG	⅜	3 9/16	50	200
⅜ x 7	STB2-37700	STB2-37700MG	⅜	5 9/16	50	200
½ x 2¾	STB2-50234R25	STB2-50234MG	½	1 ¼	25	125
½ x 3¾	STB2-50334	STB2-50334MG	½	2 1/16	25	100
½ x 4¼	STB2-50414	STB2-50414MG	½	2 9/16	25	100
½ x 4¾	STB2-50434	—	½	3 1/16	25	100
½ x 5½	STB2-50512	STB2-50512MG	½	3 13/16	25	100
½ x 7	STB2-50700	STB2-50700MG	½	5 9/16	25	100
½ x 8½	STB2-50812	—	½	6	25	100
½ x 10	STB2-50100	STB2-50100MG	½	6	25	100
½ x 12	STB2-501200R10	—	½	6	10	20
⅝ x 3½	STB2-62312R20	STB2-62312MG	⅝	1 5/8	20	80
⅝ x 4½	STB2-62412	STB2-62412MG	⅝	2 7/16	20	80
⅝ x 5	STB2-62500	STB2-62500MG	⅝	2 15/16	20	80
⅝ x 6	STB2-62600	STB2-62600MG	⅝	3 15/16	20	80
⅝ x 7	STB2-62700	—	⅝	4 15/16	20	80
⅝ x 8½	STB2-62812	STB2-62812MG	⅝	4 15/16	20	80
⅝ x 10	STB2-62100	STB2-62100MG	⅝	6	20	40
⅝ x 12	STB2-621200R10	—	⅝	6	10	20
¾ x 4¾	STB2-75434R10	STB2-75434MG	¾	2 5/8	10	40
¾ x 5½	STB2-75512	STB2-75512MG	¾	3 3/16	10	40
¾ x 6¼	STB2-75614	—	¾	3 15/16	10	40
¾ x 7	STB2-75700	STB2-75700MG	¾	4 11/16	10	40
¾ x 8½	STB2-75812	—	¾	6	10	20
¾ x 10	STB2-75100	—	¾	6	10	20
¾ x 12	STB2-751200R5	STB2-751200MG	¾	6	10	20
1 x 7	STB2-100700	—	1	3 ½	5	20
1 x 10	STB2-1001000	—	1	3 ½	5	10
1 x 13	STB2-1001300	—	1	3 ½	5	10
1 x 15	STB2-1001500	—	1	3 ½	5	10

Strong-Bolt® 2 Wedge Anchor

Strong-Bolt 2 Anchor Product Data — Stainless Steel

Size (in.)	Type 304 Stainless Steel Model No.	Type 316 Stainless Steel Model No.	Drill Bit Diameter (in.)	Thread Length (in.)	Quantity	
					Box	Carton
¼ x 1¾	STB2-251344SS	STB2-251346SS	¼	1½	100	500
¼ x 2¼	STB2-252144SS	STB2-252146SS	¼	1¾	100	500
¼ x 3¼	STB2-253144SS	STB2-253146SS	¼	2¾	100	500
⅜ x 2¼	STB2-372144SSR50	STB2-372146SSR50	⅜	1	50	250
⅜ x 2¾	STB2-372344SS	STB2-372346SS	⅜	1½	50	250
⅜ x 3	STB2-373004SS	STB2-373006SS	⅜	1¾	50	250
⅜ x 3½	STB2-373124SS	STB2-373126SS	⅜	2¼	50	250
⅜ x 3¾	STB2-373344SS	STB2-373346SS	⅜	2½	50	250
⅜ x 5	STB2-375004SS	STB2-375006SS	⅜	3¾	50	200
⅜ x 7	STB2-377004SS	STB2-377006SS	⅜	5¾	50	200
½ x 2¾	STB2-502344SSR25	STB2-502346SSR25	½	1¼	25	125
½ x 3¾	STB2-503344SS	STB2-503346SS	½	2¼	25	125
½ x 4¼	STB2-504144SS	STB2-504146SS	½	2¾	25	100
½ x 4¾	STB2-504344SS	STB2-504346SS	½	3¼	25	100
½ x 5½	STB2-505124SS	STB2-505126SS	½	3¾	25	100
½ x 7	STB2-507004SS	STB2-507006SS	½	5¾	25	100
½ x 8½	STB2-508124SS	STB2-508126SS	½	6	25	50
½ x 10	STB2-501004SS	STB2-501006SS	½	6	25	50
⅝ x 3½	STB2-623124SSR20	STB2-623126SSR20	⅝	1½	20	80
⅝ x 4½	STB2-624124SS	STB2-624126SS	⅝	2¾	20	80
⅝ x 5	STB2-625004SS	STB2-625006SS	⅝	2½	20	80
⅝ x 6	STB2-626004SS	STB2-626006SS	⅝	3¼	20	80
⅝ x 7	STB2-627004SS	STB2-627006SS	⅝	4¼	20	80
⅝ x 8½	STB2-628124SS	STB2-628126SS	⅝	6	20	40
⅝ x 10	STB2-621004SS	STB2-621006SS	⅝	6	10	20
¾ x 4¾	STB2-754344SSR10	STB2-754346SSR10	¾	2½	10	40
¾ x 5½	STB2-755124SS	STB2-755126SS	¾	3¾	10	40
¾ x 6¼	STB2-756144SS	STB2-756146SS	¾	3¼	10	40
¾ x 7	STB2-757004SS	STB2-757006SS	¾	4¼	10	40
¾ x 8½	STB2-758124SS	STB2-758126SS	¾	6	10	20

Sleeve-All® Sleeve Anchor

Sleeve-All expanding anchors are pre-assembled, expanding sleeve anchors for use in all types of solid base materials. This anchor is available in acorn, hex, rod coupler, flat or round head style for a wide range of applications.

Codes: FM 3017082, 3026805 and 3029959 (carbon steel $\frac{3}{8}$ " – $\frac{1}{2}$ " diameter); Underwriters Laboratories File Ex3605 ($\frac{3}{8}$ " – $\frac{3}{4}$ " diameter); multiple DOT listings. Meets the requirements of Federal Specification A-A-1922A.

Material: Carbon steel or stainless steel

Coating: Carbon steel anchors are zinc plated

Installation

1. Drill a hole in the base material using a carbide drill bit the same diameter as the nominal diameter of the anchor to be installed.
2. Drill the hole to the specified embedment depth, and blow it clean using compressed air. (Overhead installations need not be blown clean.) Alternatively, drill the hole deep enough to accommodate embedment depth and the dust from drilling.
3. Place the anchor in the fixture, and drive it into the hole until the washer and nut are tight against the fixture.
4. Tighten to required installation torque.

 **Caution:** Oversized holes will make it difficult to set the anchor and will reduce the anchor's load capacity.



Hex



Acorn



Rod Coupler

Flat Head
(Phillips drive)

Installation Sequence

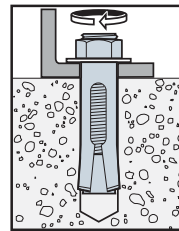
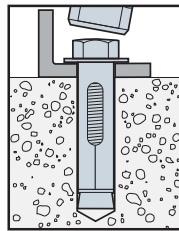
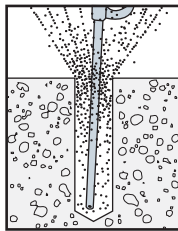
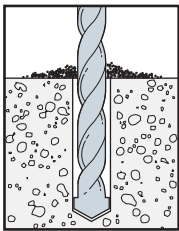

Sleeve-All® Sleeve Anchor

Material Specifications

Anchor Body	Sleeve	Nut	Washer
Carbon steel (meets minimum 50,000 psi tensile)	Carbon steel (SAE J403, Grade 1008 cold-rolled steel)	Carbon steel (ASTM A563, Grade A)	Carbon steel (SAE J403, Grade 1008/1010 cold-rolled steel)
Type 304 stainless steel	Type 304 stainless steel	Type 304 stainless steel	Type 304 stainless steel

Sleeve-All Anchor Installation Data

Sleeve-All Diameter (in.)	¼	⅝	¾	½	⅝	¾
Installation torque (ft.-lb.)	5	8	15	25	50	90
Drill bit size (in.)	¼	⅝	¾	½	⅝	¾
Wrench size ¹ (in.)	⅝	7/16	½	9/16	¾	15/16
Wrench size for coupler nut (in.)			½	⅝	¾	—

1. Applies to acorn- and hex-head configurations only.

Length Identification Head Marks on Sleeve-All Anchors
(corresponds to length of anchor — inches)

Mark	A	B	C	D	E	F	G	H	I	J	K	L	M	N	O	P	Q	R	S	T	U	V	W	X	Y	Z
From	1½	2	2½	3	3½	4	4½	5	5½	6	6½	7	7½	8	8½	9	9½	10	11	12	13	14	15	16	17	18
Up to but Not Including	2	2½	3	3½	4	4½	5	5½	6	6½	7	7½	8	8½	9	9½	10	11	12	13	14	15	16	17	18	19

Sleeve-All Anchor Product Data — Stainless Steel

Size (in.)	Model No.	Head Style	Bolt Diameter – Threads per Inch	Max. Fixture Thickness (in.)	Quantity	
					Box	Carton
¾ x 1½	SL37178HSS	Hex Head	⅝–18	¾	50	250
¾ x 3	SL37300HSS			1½	50	200
½ x 3	SL50300HSS		¾–16	¾	25	100
½ x 4	SL50400HSS			1¾	25	100

Sleeve-All® Sleeve Anchor

Sleeve-All Anchor Product Data — Zinc-Plated Carbon Steel

Size (in.)	Model No.	Head Style	Bolt Diameter – Threads per Inch	Max. Fixture Thickness (in.)	Quantity		
					Box	Carton	
¼ x 1¾	SL25138A	Acorn Head	¾-24	¼	100	500	
¼ x 2¼	SL25214A			1½	100	500	
⅝ ₁₆ x 1½	SL31112H	Hex Head	¼-20	⅜	100	500	
⅝ ₁₆ x 2½	SL31212H			1⅞	50	250	
⅜ x 1⅞	SL37178H		⅝-18	⅜	50	250	
⅜ x 3	SL37300H			1½	50	200	
⅜ x 4	SL37400H			2¼	50	200	
½ x 2¼	SL50214H		¾-16	½	50	200	
½ x 3	SL50300H			¾	25	100	
½ x 4	SL50400H			1¾	25	100	
½ x 6	SL50600H			3¾	20	80	
⅝ ₈ x 2¼	SL62214H		½-13	½	25	100	
⅝ ₈ x 3	SL62300H			¾	20	80	
⅝ ₈ x 4¼	SL62414H			1½	10	40	
⅝ ₈ x 6	SL62600H			3¼	10	40	
¾ x 2½	SL75212H		⅝-11	½	10	40	
¾ x 4¼	SL75414H			⅞	10	40	
¾ x 6¼	SL75614H			2⅞	5	20	
¼ x 2	SL25200PF		Phillips Flat Head	¾-24	⅞	100	500
¼ x 3	SL25300PF				1⅞	50	250
⅝ ₁₆ x 2½	SL31212PF			¼-20	1⅞	50	250
⅝ ₁₆ x 3½	SL31312PF				2⅞	50	250
⅜ x 2¾	SL37234PF	⅝-18		1¼	50	200	
⅜ x 4	SL37400PF			2½	50	200	
⅜ x 5	SL37500PF			3½	50	200	
⅜ x 6	SL37600PF			4½	50	200	

Sleeve-All Anchor (with rod coupler) Product Data — Zinc-Plated Carbon Steel

Size (in.)	Model No.	Accepts Rod Diameter (in.)	Wrench Size	Quantity	
				Box	Carton
⅜ x 1⅞	SL37178C	⅜	½	50	200
½ x 2¼	SL50214C	½	⅝	25	100
⅝ ₈ x 2¼	SL62214C	⅝	¾	20	80

Easy-Set Pin-Drive Expansion Anchor

The Easy-Set is a pin-drive expansion anchor for medium- and heavy-duty fastening applications into concrete and grout-filled block. Integrated nut and washer help keep track of parts.

Material: Carbon steel

Coating: Yellow zinc dichromate plated

Installation

 **Caution:** Oversized holes in the base material will make it difficult to set the anchor and will reduce the anchor's load capacity.

1. Drill a hole in the base material using a carbide drill bit the same diameter as the nominal diameter of the anchor to be installed. Drill the hole to the specified embedment depth plus $\frac{1}{4}$ " to allow for pin extension and blow it clean using compressed air. (Overhead installations need not be blown clean.) Alternatively, drill the hole deep enough to accommodate embedment depth and the dust from drilling.
2. Adjust the nut for required embedment. Place the anchor through the fixture and into the hole.
3. Hammer the center pin until the bottom of the head is flush with top of anchor.



Easy-Set
(EZAC)

Installation Sequence

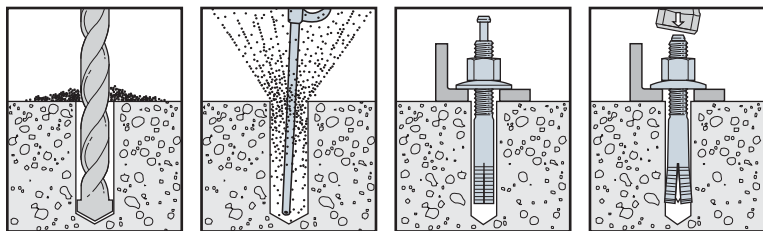

Easy-Set Anchor Installation Data

Easy-Set Diameter (in.)	$\frac{3}{8}$	$\frac{1}{2}$	$\frac{5}{8}$
Drill bit size (in.)	$\frac{3}{8}$	$\frac{1}{2}$	$\frac{5}{8}$
Min. fixture hole size (in.)	$\frac{7}{16}$	$\frac{9}{16}$	$\frac{11}{16}$
Wrench size (in.)	$\frac{9}{16}$	$\frac{3}{4}$	$\frac{15}{16}$

Easy-Set Pin-Drive Expansion Anchor

EZAC Product Data

Size (in.)	Model No.	Thread Length (in.)	Quantity	
			Box	Carton
$\frac{3}{8}$ x 2 $\frac{3}{8}$	EZAC37238	1	50	250
$\frac{3}{8}$ x 3 $\frac{1}{2}$	EZAC37312	1 $\frac{1}{8}$	50	250
$\frac{3}{8}$ x 4 $\frac{3}{4}$	EZAC37434	1 $\frac{1}{2}$	50	200
$\frac{1}{2}$ x 2 $\frac{3}{4}$	EZAC50234	1	25	125
$\frac{1}{2}$ x 3 $\frac{1}{2}$	EZAC50312	1 $\frac{1}{8}$	25	125
$\frac{1}{2}$ x 4 $\frac{3}{4}$	EZAC50434	1 $\frac{1}{2}$	25	100
$\frac{1}{2}$ x 6	EZAC50600	2	25	100
$\frac{5}{8}$ x 4	EZAC62400	1 $\frac{5}{8}$	15	60
$\frac{5}{8}$ x 4 $\frac{3}{4}$	EZAC62434	1 $\frac{5}{8}$	15	60
$\frac{5}{8}$ x 6	EZAC62600	2	15	60

Tie-Wire Wedge Anchor

The tie-wire anchor is a wedge-style expansion anchor for use in normal-weight concrete or in concrete over metal deck. With a tri-segmented, dual-embossed clip, the tie-wire anchor is ideal for the installation of acoustic ceiling grid and is easily set with the claw of a hammer.

Features

- ¼" eyelet for easy threading of wire
- Sets with claw of hammer
- Tri-segmented clip — each segment adjusts independently to hole irregularities
- Dual embossments on each clip segment enable the clip to undercut into the concrete, increasing follow-up expansion
- Wedge-style expansion anchor for use in normal-weight concrete or concrete over metal deck

Material: Carbon steel

Coating: Zinc plated

Installation

1. Drill a hole at least 1 ¼" deep using a ¼"-diameter carbide tipped bit.
2. Drive the anchor into the hole until the bottom of the head is flush with the base material.
3. Set the anchor by prying/pulling the head with the claw end of the hammer.



Tie-Wire
Wedge Anchor

Installation Sequence

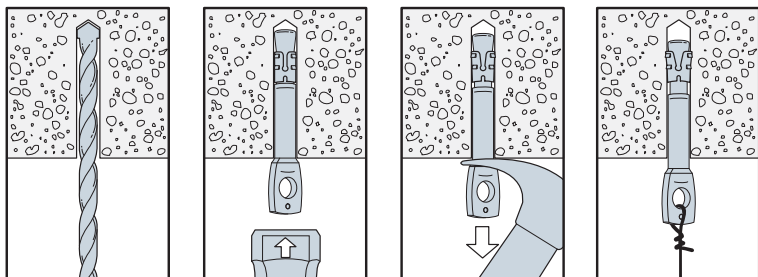

Size (in.)	Model No.	Drill Bit Diameter (in.)	Eyelet Hole Size (in.)	Quantity	
				Box	Carton
¼ x 1 ¼	TW25114	¼	¼	100	500

Titen Turbo™ Concrete and Masonry Screw Anchor

The Titen Turbo screw anchor features an innovative Torque Reduction Channel to trap drilling dust where it can't obstruct thread action, significantly reducing binding, stripping, and snapping without compromising strength. The patented reverse thread design enables smooth driving with less torque while providing superior holding power. The Torque Reduction Channel also allows more space for dust to help prevent anchors from bottoming out in smaller-diameter screw holes. The Titen Turbo screw anchors feature a serrated leading edge to cut into concrete or masonry, and a pointed tip for fast, easy installation in wood-to-concrete and wood-to-wood anchoring applications.

NEW



Titen Turbo
Flat Head
Screw
Patent
Pending

Titen Turbo
Hex-Head
Screw
Patent
Pending

Titen Turbo
Trim-Head
Screw

Features

- Patent-pending Torque Reduction Channel that displaces dust where it can't obstruct the thread action, reducing the likelihood of binding in the hole.
- Availability with either a hex head, or, for a flush profile, a 6-lobe-drive countersunk flat head or trim head.
- The 6-lobe drive's larger contact area provides better bit grip for reduced cam-outs, more torque, better performance and longer bit life.
- 6-lobe bit included in packaging for countersunk flat head and trim head version.
- Superior tension load performance compared to leading competitors in the market.
- Matched-tolerance bit not required; use a standard ANSI drill bit for installation.
- Serrated screw point for easier starts when fastening wood.
- Designed for installation with an impact driver or cordless drill. Installation using the Titen Turbo Installation Tool is recommended.
- Use in dry interior environments only.
- Code listed in accordance with ICC-ES AC193 for uncracked concrete and ICC-ES AC106 for masonry applications without cleaning dust from predrilled holes.

Codes: IAPMO UES ER-712 (uncracked concrete)
(City of LA Supplement within ER-712);
IAPMO UES ER-716 (masonry)
(City of LA Supplement within ER-716);
FL16230 (concrete and masonry)

Material: Carbon steel

Coating: Zinc plated with baked ceramic coating



6-lobe drive

Versatile Applications



Sliding door track installation



Window frames



Furring strips

Installation Sequence

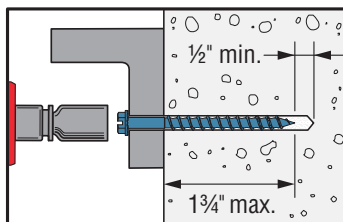
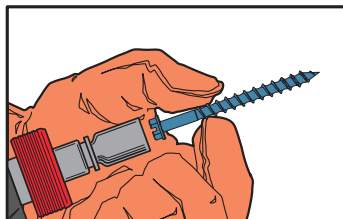
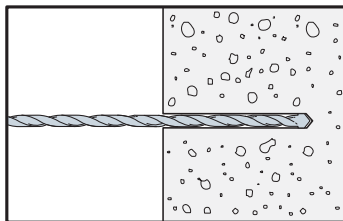

Titen Turbo™ Concrete and Masonry Screw Anchor

Blue Titen Turbo Product Data (3/16" diameter)

Size (in.)	Head Style	Model No.	Drill Bit Diameter (in.)	Quantity	
				Pack	Carton
3/16 x 1 1/4	1/4" hex	TNT18114H	5/32	100	1,600
3/16 x 1 3/4		TNT18134H		100	500
3/16 x 2 1/4		TNT18214H		100	500
3/16 x 2 3/4		TNT18234H		100	500
3/16 x 3 1/4		TNT18314H		100	400
3/16 x 3 3/4		TNT18334H		100	400
3/16 x 1 1/4	T25 6-lobe flat	TNT18114TF	5/32	100	1,600
3/16 x 1 3/4		TNT18134TF		100	500
3/16 x 2 1/4		TNT18214TF		100	500
3/16 x 2 3/4		TNT18234TF		100	500
3/16 x 3 1/4		TNT18314TF		100	400
3/16 x 3 3/4		TNT18334TF		100	400



Blue Titen Turbo Product Data (1/4" diameter)

Size (in.)	Head Style	Model No.	Drill Bit Diameter (in.)	Quantity	
				Pack	Carton
1/4 x 1 1/4	5/16" hex	TNT25114H	3/16	100	1,600
1/4 x 1 3/4		TNT25134H		100	500
1/4 x 2 1/4		TNT25214H		100	500
1/4 x 2 3/4		TNT25234H		100	500
1/4 x 3 1/4		TNT25314H		100	400
1/4 x 3 3/4		TNT25334H		100	400
1/4 x 4		TNT25400H		100	400
1/4 x 5		TNT25500H		100	400
1/4 x 6		TNT25600H		100	400
1/4 x 1 1/4	T30 6-lobe flat	TNT25114TF	3/16	100	1,600
1/4 x 1 3/4		TNT25134TF		100	500
1/4 x 2 1/4		TNT25214TF		100	500
1/4 x 2 3/4		TNT25234TF		100	500
1/4 x 3 1/4		TNT25314TF		100	400
1/4 x 3 3/4		TNT25334TF		100	400
1/4 x 4		TNT25400TF		100	400



Titen Turbo™ Concrete and Masonry Screw Anchor

White Titen Turbo Product Data (6-Lobe Flat Head)

Size (in.)	Head Style	Model No.	Drill Bit Diameter (in.)	Quantity	
				Pack	Carton
3/16 x 1 1/4	T25 6-lobe flat	TNTW18114TF	5/32	100	1,600
3/16 x 1 3/4		TNTW18134TF		100	500
3/16 x 2 1/4		TNTW18214TF		100	500
3/16 x 2 3/4		TNTW18234TF		100	500
3/16 x 3 1/4		TNTW18314TF		100	400
3/16 x 3 3/4		TNTW18334TF		100	400
1/4 x 1 1/4	T30 6-lobe flat	TNTW25114TF	3/16	100	1,600
1/4 x 1 3/4		TNTW25134TF		100	500
1/4 x 2 1/4		TNTW25214TF		100	500
1/4 x 2 3/4		TNTW25234TF		100	500
1/4 x 3 1/4		TNTW25314TF		100	400
1/4 x 3 3/4		TNTW25334TF		100	400

Silver Titen Turbo Product Data (6-Lobe Flat Head)

Size (in.)	Head Style	Model No.	Drill Bit Diameter (in.)	Quantity
3/16 x 1 3/4	T25 6-lobe flat	TNTS18134TFB	5/32	1,000
3/16 x 2 3/4		TNTS18234TFB		1,000
3/16 x 3 3/4		TNTS18334TFB		1,000
1/4 x 2 3/4	T30 6-lobe flat	TNTS25234TFB	3/16	1,000
1/4 x 3 3/4		TNTS25314TFB		1,000

White Titen Turbo Trim-Head Product Data (6-Lobe)

Size (in.)	Model No.	Drill Bit Diameter (in.)	Bit Size	Quantity	
				Box	Carton
1/4 x 2 3/4	TNTW25234TTR	3/16	T25	100	500
1/4 x 3 1/4	TNTW25314TTR			100	400
1/4 x 2 3/4	TNTW25234TTRB			1,000	—
1/4 x 3 1/4	TNTW25314TTRB			1,000	—

Bronze Titen Turbo Trim-Head Product Data (6-Lobe)

Size (in.)	Model No.	Drill Bit Diameter (in.)	Bit Size	Quantity	
				Box	Carton
1/4 x 2 3/4	TNTB25234TTR	3/16	T25	100	500
1/4 x 3 1/4	TNTB25314TTR			100	400
1/4 x 2 3/4	TNTB25234TTRB			1,000	—
1/4 x 3 1/4	TNTB25314TTRB			1,000	—



Titen Turbo™ Concrete and Masonry Screw Anchor

Titen Turbo Screw Anchor — Installation Tool

Six-piece kit includes:

- 6-lobe bit socket
- T25 and T30 bits
- 1/4" and 5/16" hex sockets
- Canvas storage bag



Titen Turbo Installation Tool

Model No.	Quantity	
	Clamshell	Carton
TNTINSTALLKIT	1	4

Titen Turbo Screw Anchor Installation Kit

Titen Turbo Screw Anchor — Drill Bits

Model No.	Description	Pack Quantity	Carton Quantity
MDB15312C1	Masonry bit 5/32" x 3 1/2" – 1 card	1	10
MDB15412C1	Masonry bit 5/32" x 4 1/2" – 1 card	1	10
MDB15412C4	Masonry bit 5/32" x 4 1/2" – 4 card	4	10
MDB15512C1	Masonry bit 5/32" x 5 1/2" – 1 card	1	10
MDB18312C1	Masonry bit 3/16" x 3 1/2" – 1 card	1	10
MDB18412C1	Masonry bit 3/16" x 4 1/2" – 1 card	1	10
MDB18412C4	Masonry bit 3/16" x 4 1/2" – 4 card	4	10
MDB18512C1	Masonry bit 3/16" x 5 1/2" – 1 card	1	10

Titen Turbo Screw Anchor — SDS-plus® Drill Bits

Size (in.)	Model No.	For Screw Diameter (in.)	Drilling Depth (in.)	Overall Length (in.)
5/32 x 6	MDPLO1506H	3/16	3 1/8	6
5/32 x 7	MDPLO1507H		4 1/8	7
3/16 x 5	MDPLO1805H	1/4	2 3/8	5
3/16 x 6	MDPLO1806H		3 1/8	6
3/16 x 7	MDPLO1807H		4 1/8	7

Titen drivers are sold individually.

Titen Turbo Screw Drill Bit — Bulk Packs*

Diameter (in.)	Drilling Depth (in.)	Overall Length (in.)	For Screw Diameter (in.)	Model No.
5/32	4 1/8	7	3/16	MDPLO1507H-R25
3/16	4 1/8	7	1/4	MDPLO1807H-R25

*SDS-plus shank.



SDS-plus Shank Bit

Titen® Stainless-Steel Concrete and Masonry Screw

Stainless-steel Titen screws are ideal for attaching various types of components to concrete and masonry, such as fastening electrical boxes or light fixtures. They offer the versatility of our standard Titen screws with enhanced corrosion protection. Available in hex and Phillips flat head.

Features

- Suitable for concrete, brick, grout-filled CMU and hollow-block applications
- Suitable for some preservative-treated wood applications
- Acceptable for exterior use
- Titen drill bits included in each box
- Available in lengths from 1 ¼"–4"
- Installation using the Titen Installation Kit is recommended

Codes: FL2355

Material: Type 410 stainless steel

Coating: Zinc plated with a protective overcoat

Installation

 **Caution:** Industry studies show that hardened fasteners can experience performance problems in wet or corrosive environments. Steps must be taken to prevent inadvertent sustained loads above the listed allowable loads. Overtightening and bending moments can initiate cracks detrimental to the hardened screw's performance. Use the Simpson Strong-Tie Titen installation tool kit as it has a bit that is designed to reduce the potential for overtightening the screw.

 **Caution:** Oversized holes in the base material will reduce or eliminate the mechanical interlock of the threads with the base material and will reduce the anchor's load capacity.

1. Drill a hole in the base material using the appropriate diameter carbide drill bit as specified in the table. Drill the hole to the specified embedment depth plus ½" to allow the thread tapping dust to settle and blow it clean using compressed air. Overhead installations need not be blown clean. Alternatively, drill the hole deep enough to accommodate embedment depth and dust from drilling and tapping.
2. Position fixture, insert screw and tighten using drill and Titen screw installation tool fitted with a hex socket or Phillips bit.

Preservative-treated wood applications: suitable for use in non-ammonia formulations of CCA, ACQ-C, ACQ-D, CA-B, SBX/DOT and zinc borate. Acceptable for use in exterior environments. Use caution not to damage coating during installation. The 410 stainless-steel Titen with top coat provides "medium" corrosion protection. Recommendations are based on testing and experience at time of publication and may change. Simpson Strong-Tie cannot provide estimates on service life of screws.



Titen
Stainless-Steel
Phillips Flat-Head Screw
(PFSS)



Titen
Stainless-Steel
Hex-Head Screw
(HSS)

Titen® Stainless-Steel Concrete and Masonry Screw

Installation Sequence

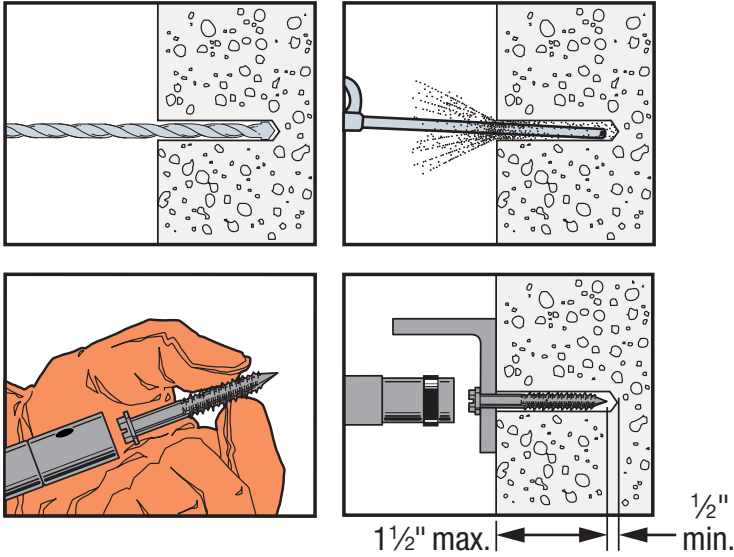

Stainless-Steel Titen Product Data

Size (in.)	Head Style	Model No.	Drill Bit Diameter (in.)	Quantity	
				Box	Carton
1/4 x 1 1/4	Hex head	TTN25114HSS	3/16	100	1,600
1/4 x 1 3/4		TTN25134HSS		100	500
1/4 x 2 1/4		TTN25214HSS		100	500
1/4 x 2 3/4		TTN25234HSS		100	500
1/4 x 3 1/4		TTN25314HSS		100	400
1/4 x 3 3/4		TTN25334HSS		100	400
1/4 x 4		TTN25400HSS		100	400
1/4 x 1 1/4	Phillips flat head	TTN25114PFSS	3/16	100	1,600
1/4 x 1 3/4		TTN25134PFSS		100	500
1/4 x 2 1/4		TTN25214PFSS		100	500
1/4 x 2 3/4		TTN25234PFSS		100	500
1/4 x 3 1/4		TTN25314PFSS		100	400
1/4 x 3 3/4		TTN25334PFSS		100	400
1/4 x 4		TTN25400PFSS		100	400

One drill bit is included in each box.

See p. 78 for Titen screw installation accessories.

Titen HD® Threaded Rod Hanger

The Titen HD threaded rod hanger is a high-strength screw anchor designed to suspend threaded rod from concrete slabs, beams or concrete over metal in order to hang pipes, cable trays and other HVAC equipment. The anchor offers low installation torque with no secondary setting, and has been tested to offer industry-leading performance in cracked and uncracked concrete — even in seismic loading conditions.

Features

- Thread design undercuts to efficiently transfer the load to the base material
- Serrated cutting teeth and patented thread design enable quick and easy installation
- Specialized heat-treating process creates tip hardness to facilitate cutting while the anchor body remains ductile
- No special drill bit required — designed to install using standard-sized ANSI tolerance drill bits
- Installs with standard-sized sockets

Codes: ICC-ES ESR-2713;
City of LA Supplement within ESR-2713;
FL15730;
Factory Mutual 3031136 (THD50234RH)
and 3061897 (THDB37158RH)

Material: Carbon steel

Coating: Zinc plated

Installation



Caution: Oversized holes in the base material will reduce or eliminate the mechanical interlock of the threads with base material and will reduce the anchor's load capacity.



Caution: Use a Titen HD rod hanger one time only. Installing the anchor multiple times may result in excessive thread wear and reduce load capacity.

1. Drill a hole using the specified diameter carbide bit into the base material to the specified embedment depth plus minimum hole depth overdrill (see the product data table on p. 82).
2. Blow the hole clean of dust and debris using compressed air.
3. Install the anchor into the hole.
4. Fully insert threaded rod.



THD50234RH
($\frac{3}{8}$ "-dia. shank)



THDB37158RH
($\frac{1}{4}$ "-dia. shank)



THDB25158RH
($\frac{1}{4}$ "-dia. shank)

Titen HD® Threaded Rod Hanger

Installation Sequence

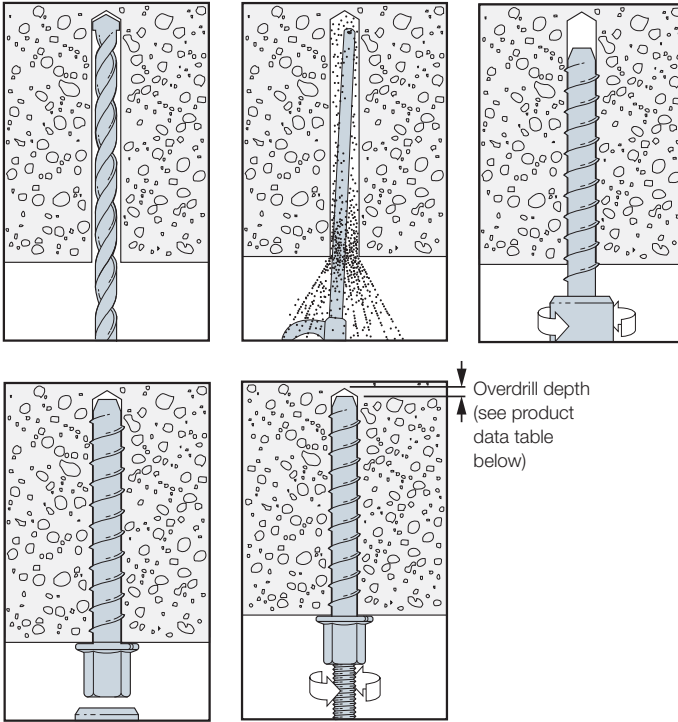

Titen HD Threaded Rod Hanger Product Data

Size (in.)	Model No.	Accepts Rod Dia. (in.)	Drill Bit Dia. (in.)	Wrench Size (in.)	Min. Embed. (in.)	Hole Depth Overdrill (in.)	Quantity	
							Box	Carton
1/4 x 1 1/8	THDB25158RH	1/4	1/4	3/8	1 5/8	1/8	100	500
3/8 x 1 1/8	THDB37158RH	3/8	1/4	1/2	1 5/8	1/8	50	200
1/2 x 2 3/4	THD50234RH	1/2	3/8	1 1/16	2 1/2	1/4	50	100



Steel Rod Hanger Threaded Rod Anchor System

The Simpson Strong-Tie® steel rod hanger is a one-piece fastening system for suspending ¼" and ⅜" threaded rod. Vertical rod hangers are designed to suspend threaded rod in overhead applications from steel joists and beams. Horizontal rod hangers are available for applications requiring installation into the side of joists, columns and overhead members. Both rod hangers provide attachment points for use in pipe hanging, fire protection, electrical conduit and cable-tray applications. Recommended for use in dry, interior, non-corrosive environments only.



RSH
Horizontal Steel
Rod Hangers

Features

- Threaded anchors for rod-hanging applications in steel members
- Suitable to be installed horizontally or vertically in overhead applications
- Self-drilling tip, no predrilling required
- Recommend installation with a 18V cordless drill/driver
- Custom-matched nut driver sets anchor to optimal depth

Codes: FM 3058980;
UL File Ex3605

Material: Carbon steel

Coating: Zinc plated



RSV
Vertical Steel
Rod Hangers

Nut Driver

Custom-matched nut driver sets the rod hangers to optimal depth every time.

Model No.	Description	Quantity	
		Box	Carton
RND62	Nut driver	10	60



RND62

Steel Rod Hanger Threaded Rod Anchor System

Steel Rod Hangers

Rod Diameter (in.)	Size	Model No.	Drill Point	Application	Steel Thickness Range	Quantity	
						Box	Carton
1/4	1/4" x 1" with nut	RSH25100N	#3	Horizontal	20 ga. – 12 ga.	25	250
1/4	#12–20 x 1 1/2"	RSH25112-5	#5		20 ga. – 1/4"		
3/8	1/4" x 1" with nut	RSH37100N	#3		20 ga. – 12 ga.		
3/8	#12–20 x 1 1/2"	RSH37112N-5	#5		20 ga. – 1/4"		
1/4	1/4" x 1"	RSV25100	#3	Vertical	20 ga. – 12 ga.	25	250
3/8	1/4" x 1" with nut	RSV37100N	#3		20 ga. – 12 ga.		
3/8	1/4" x 1 1/2"	RSV37112	#3		20 ga. – 14 ga.		
3/8	1/4" x 1 1/2" with nut	RSV37112N	#3		20 ga. – 14 ga.		
3/8	#12–20 x 1 1/2"	RSV37112N-5	#5		20 ga. – 1/4"		
3/8	1/4" x 2"	RSV37200	#3		20 ga. – 14 ga.		

Vertical Installation

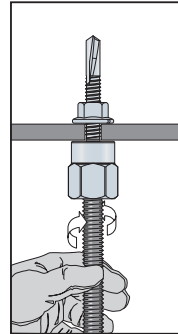
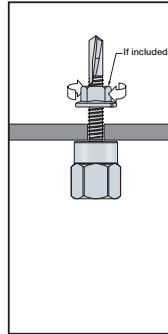
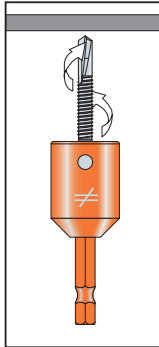
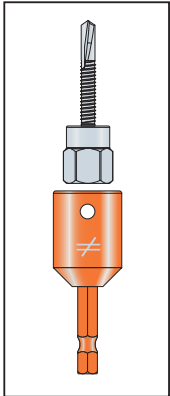

Steel Rod Hanger Threaded Rod Anchor System

Horizontal Installation

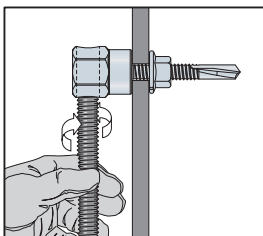
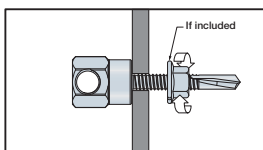
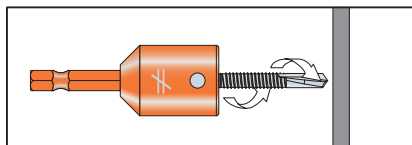
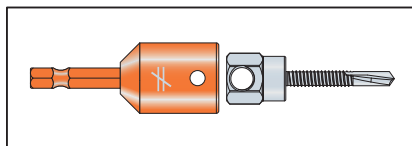

Wood Rod Hanger Threaded Rod Anchor System

The wood rod hanger from Simpson Strong-Tie is a one-piece fastening system for suspending $\frac{1}{4}$ " or $\frac{3}{8}$ " threaded rod. Vertical rod hangers are designed to suspend threaded rod in overhead applications from wood members. Horizontal rod hangers are available for applications requiring installation into the side of joists, columns and overhead members. Both rod hangers provide attachment points for use in pipe hanging, fire protection, electrical conduit and cable-tray applications. Recommended for use in dry, interior, non-corrosive environments only.

Features

- Threaded anchors for rod-hanging applications in wood
- Suitable for installation horizontally or vertically in overhead applications
- No predrilling required
- Type-17 point provides for fast starts
- Recommend installation with a 18V cordless drill/driver or 18V cordless impact driver

Codes: FM 3058980; UL File Ex3605

Material: Carbon steel

Coating: Zinc plated



RWW
Vertical Wood
Rod Hanger



RWH
Horizontal Wood
Rod Hanger



Type-17 point
for use in wood

Wood Rod Hangers

Rod Diameter (in.)	Size (in.)	Model No.	Application	Point Style	Quantity	
					Box	Carton
$\frac{1}{4}$	$\frac{1}{4} \times 2$	RWW25200	Vertical	Type 17	25	250
$\frac{3}{8}$	$\frac{1}{4} \times 1$	RWW37100				
$\frac{3}{8}$	$\frac{1}{4} \times 2$	RWW37200				
$\frac{3}{8}$	$\frac{5}{16} \times 2\frac{1}{2}$	RWW37212	Horizontal	Type 17	25	250
$\frac{1}{4}$	$\frac{1}{4} \times 1$	RWH25100				
$\frac{3}{8}$	$\frac{1}{4} \times 2$	RWH37200				
$\frac{3}{8}$	$\frac{5}{16} \times 2\frac{1}{2}$	RWH37212				

Wood Rod Hanger Threaded Rod Anchor System

Installation Sequence

1. Attach RND62 nut driver to a drill.
2. Insert rod hanger into the RND62 nut driver.
3. Using rotation-only mode, drive rod hanger until it contacts the surface. Do not over-tighten. RND62 nut driver will disengage the rod hanger at the appropriate depth to prevent overdriving.
4. Insert threaded rod. Minimum thread engagement should be equal to the nominal diameter of the threaded insert.

Vertical Wood Rod Hanger

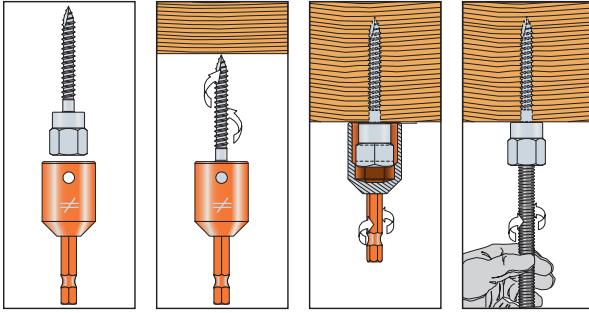

Horizontal Wood Rod Hanger

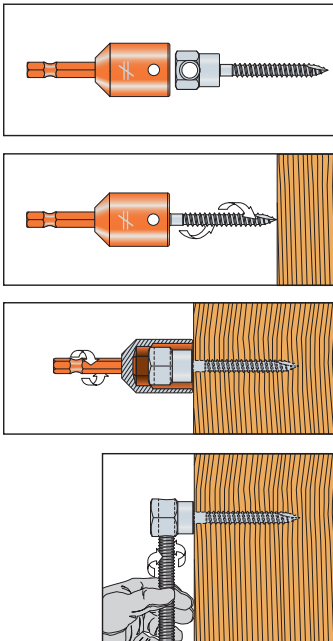

Drop-In Internally Threaded Anchor (DIAB)

Expansion shell anchors for use in solid base materials

Simpson Strong-Tie introduces a redesigned Drop-In Anchor (DIAB) that provides easier installation into base materials. Improved geometry in the preassembled expansion plug improves setting capability so the anchor installs with 40% fewer hammer strikes than previous versions. These displacement-controlled expansion anchors are easily set by driving the plug toward the bottom of the anchor using either the hand- or power-setting tools. DIAB anchors feature a positive-set marking indicator at the top of the anchor — helping you see more clearly when proper installation has taken place.

Use a Simpson Strong-Tie fixed-depth stop bit to take the guesswork out of drilling to the correct depth. The fluted design of the tip draws debris away from the hole during drilling, allowing for a cleaner installation.

Key features

- New design offers easier installation than previous drop-in anchor design — sets with 40% fewer hammer hits
- Positive-set marking system indicates when anchor is properly set
- Lipped drop-in version available for flush installation
- Hand- and power-setting tools available for fast, easy and economical installation
- Fixed-depth stop bit helps you drill to the correct depth every time
- Available in coil-thread version for ½" and ¾" coil-thread rod

Codes: FM 3053987; UL File Ex3605; multiple DOT listings.
Meets the requirements of Federal Specification A-A-55614, Type 1.

Material: Carbon steel

Coating: Zinc plated



Drop-In

Lipped
Drop-InCoil-Thread
Drop-In

Drop-In Internally Threaded Anchor (DIAB)

Fixed-Depth Drill Bits for DIAB

Model No.	Drill Bit Diameter (in.)	Drill Depth (in.)	Drop-In Anchor (in.)
MDPL037DIA	$\frac{3}{8}$	$1\frac{1}{16}$	$\frac{1}{4}$
MDPL050DIA	$\frac{1}{2}$	$1\frac{11}{16}$	$\frac{3}{8}$
MDPL062DIA	$\frac{5}{8}$	$2\frac{1}{16}$	$\frac{1}{2}$



Anchor being set with hand setting tool.



Anchor being set with SDS setting tool.



Positive set indicator.



Fixed-Depth Drill Bit

Drop-In Internally Threaded Anchor (DIAB)

Drop-In Anchor

Rod Size (in.)	Model No.	Drill Bit Dia. (in.)	Bolt Threads (per in.)	Body Length (in.)	Thread Length (in.)	Quantity	
						Box	Carton
¼	DIAB25	¾	20	1	¾	100	500
¾	DIAB37	½	16	1⅞	⅝	50	250
½	DIAB50	⅝	13	2	¾	50	200
⅝	DIAB62	⅞	11	2½	1	25	100
¾	DIAB75	1	10	3⅞	1¼	20	80



Drop-In

Lipped Drop-In Anchor

Rod Size (in.)	Model No.	Drill Bit Dia. (in.)	Bolt Threads (per in.)	Body Length (in.)	Thread Length (in.)	Quantity	
						Box	Carton
¼	DIABL25	¾	20	1	¾	100	500
¾	DIABL37	½	16	1⅞	⅝	50	250
½	DIABL50	⅝	13	2	¾	50	200



Lipped Drop-In

Coil-Thread Drop-In Anchor

Rod Size (in.)	Model No.	Drill Bit Dia. (in.)	Bolt Threads (per in.)	Body Length (in.)	Thread Length (in.)	Quantity	
						Box	Carton
½	DIAB50C ¹	⅝	6	2	¾	50	200
¾	DIAB75C ¹	1	4½	3⅞	1¼	20	80

1. DIAB50C and DIAB75C accept ½" and ¾" coil-thread rod, respectively.



Coil-Thread Drop-In

Drop-In Internally Threaded Anchor (DIAB)

DIABST Drop-In Anchor Hand-Setting Tool

Hand-setting tool designed for use with the Simpson Strong-Tie® Drop-In anchor (DIAB), ensuring fast, easy and economical installation.



Hand Setting Tool

Model No.	Description	Box Quantity	Carton Qty.
DIABST25	Setting tool for use with Drop-In models DIAB25, DIABL25	10	50
DIABST37	Setting tool for use with Drop-In models DIAB37, DIABL37	10	50
DIABST50	Setting tool for use with Drop-In models DIAB50, DIABL50, DIAB50C	10	50
DIABST62	Setting tool for use with Drop-In model DIAB62	5	25
DIABST75	Setting tool for use with Drop-In models DIAB75, DIAB75C	5	20

1. Setting tools sold separately. Tools may be ordered by the piece.

DIABST (SDS-plus®) Drop-In Anchor Power-Setting Tool

Power-setting tool featuring an SDS-plus shank, designed for use with the Simpson Strong-Tie Drop-In anchor (DIAB), ensuring fast, easy and economical installation.



Power Setting Tool

Model No.	Description	Box Quantity	Carton Qty.
DIABST25-SDS	Power-setting tool for use with Drop-In models DIAB25, DIABL25	10	50
DIABST37-SDS	Power-setting tool for use with Drop-In models DIAB37, DIABL37	10	50
DIABST50-SDS	Power-setting tool for use with Drop-In models DIAB50, DIABL50, DIAB50C	10	50

1. Setting tools sold separately. Tools may be ordered by the piece.

Drop-In Internally Threaded Anchor (DIAB)

DIAB Manual Installation

⚠ Caution: Oversized holes will reduce the anchors load capacity.

1. Drill a hole in the base material using the appropriate diameter carbide drill bit or fixed-depth bit as specified in the table. Drill the hole to the specified embedment. For fixed-depth bits drill the hole until the shoulder of the bit contacts the surface of the base material. Then blow the hole clean of dust and debris using compressed air. Overhead installations need not be blown clean.
2. Insert the anchor into the hole. Tap with hammer until flush against the surface.
3. Using the designated Drop-In setting tool, drive expander plug towards the bottom of the anchor until the shoulder of the setting tool makes contact with the top of the anchor. When properly set four indentations will be visible on the top of the anchor indicating full expansion.
4. Insert bolt or threaded rod. Minimum thread engagement should be equal to the nominal diameter of the threaded insert.

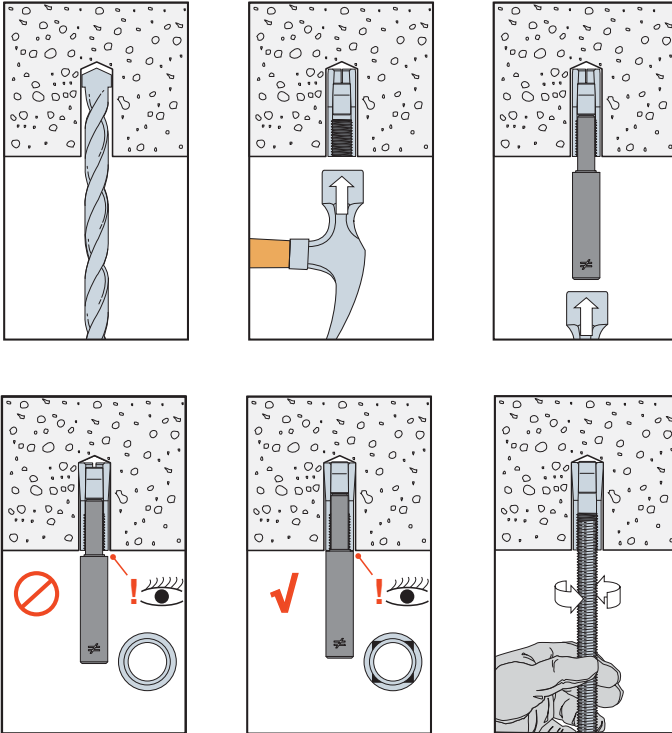

Drop-In Internally Threaded Anchor (DIAB)

DIAB SDS Installation



Caution: Oversized holes will reduce the anchors load capacity.

1. Drill a hole in the base material using the appropriate diameter carbide drill bit or fixed-depth drill bit as specified in the table. Drill the hole to the specified embedment. For fixed-depth bits drill the hole until the shoulder of the bit contacts the surface of the base material. Then blow the hole clean of dust and debris using compressed air. Overhead installations need not be blown clean.
2. Insert the anchor into the hole. Tap with hammer until flush against the surface.
3. Attach SDS Drop-In setting tool to a drill. Drive expander plug towards the bottom of the anchor using only hammer mode until the shoulder of the setting tool makes contact with the top of the anchor. When properly set four indentations will be visible on the top of the anchor indicating full expansion.
4. Insert bolt or threaded rod. Minimum thread engagement should be equal to the nominal diameter of the threaded insert.

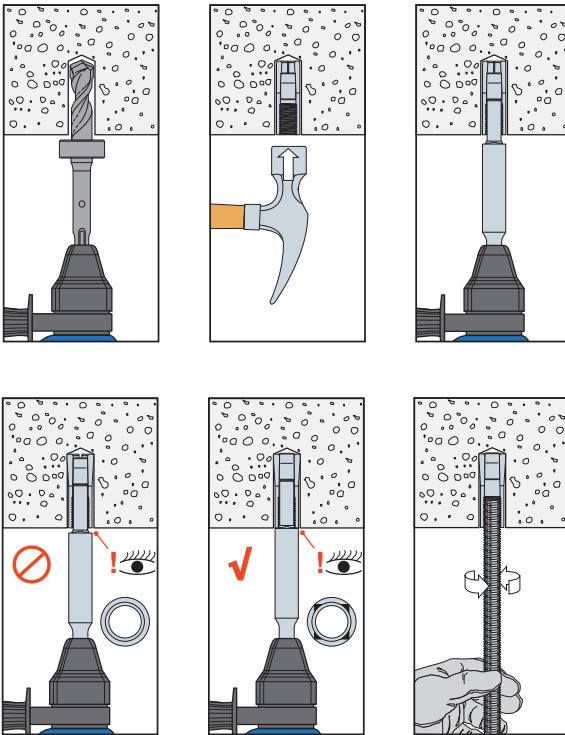

Drop-In Short / Drop-In Stainless Steel Internally Threaded Anchor (DIA)

Drop-in anchors are internally threaded drop-in expansion anchors for use in flush-mount applications in solid base materials. Available in stainless steel (DIA) or short (DIAS) version. Minimum thread engagement should be equal to the nominal diameter of the threaded insert.

Features

- Lipped edge (DIAS) eliminates need for precisely drilled hole depth
- Hand- and power-setting tools available for fast, easy and economical installation
- Fixed-depth stop bit helps you drill to the correct depth every time
- Short length (DIAS) enables shallow embedment to help avoid drilling into rebar or pre-stressed/post-tensioned cables
- Short drop-in anchors include a setting tool compatible with the anchor to ensure consistent installation

Codes: DOT; Factory Mutual 3017082; Underwriters Laboratories File Ex3605. Meets the requirements of Federal Specifications A-A-55614, Type I.

Material: Stainless steel and carbon steel

Coating: Carbon steel; zinc plated

Installation

Caution: The load tables list values based upon results from the most recent testing and may not reflect those in current code reports. Where code jurisdictions apply, consult the current reports for applicable load values.

1. Drill a hole in the base material using the appropriate diameter carbide drill bit as specified in the table. Drill the hole to the specified embedment depth plus $\frac{1}{8}$ " for flush mounting. Blow the hole clean using compressed air. Overhead installations need not be blown clean.
2. Insert designated drop-in anchor into hole. Tap with hammer until flush against surface.
3. Using the designated drop-in setting tool, drive expander plug toward the bottom of the anchor until shoulder of setting tool makes contact with the top of the anchor.
4. Minimum thread engagement should be equal to the nominal diameter of the threaded insert.

Caution: Oversized holes will make it difficult to set the anchor and will reduce the anchor's load capacity.



**Drop-In
Stainless Steel**



Short Drop-In

Drop-In Short / Drop-In Stainless Steel Internally Threaded Anchor (DIA)

Installation Sequence

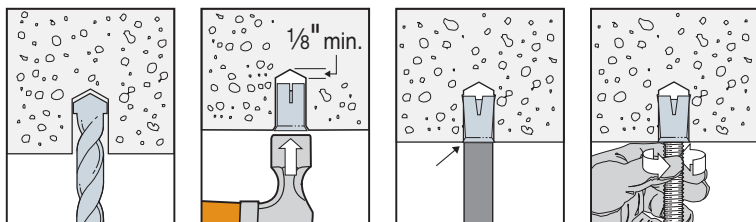

Drop-In Anchor Product Data — Stainless Steel

Rod Size (in.)	Type 303/304 Stainless Model No.	Type 316 Stainless Model No.	Drill Bit Diameter (in.)	Bolt Threads (per in.)	Body Length (in.)	Thread Length (in.)	Quantity	
							Box	Carton
1/4	DIA25SS	DIA256SS	3/8	20	1	3/8	100	500
3/8	DIA37SS	DIA376SS	1/2	16	1 9/16	5/8	50	250
1/2	DIA50SS	DIA506SS	5/8	13	2	3/4	50	200
5/8	DIA62SS	—	7/8	11	2 1/2	1	25	100
3/4	DIA75SS	—	1	10	3 1/8	1 1/4	20	80

Short Drop-In Anchor Product Data

Rod Size (in.)	Model No.	Drill Bit Diameter (in.)	Bolt Threads (per in.)	Body Length (in.)	Thread Length (in.)	Quantity	
						Box	Carton
3/8	DIA37S ¹	1/2	16	3/4	1/4	100	500
1/2	DIA50S ¹	5/8	13	1	5/16	50	200

1. A dedicated setting tool is included with each box of DIA37S and DIA50S.

Material Specifications

Anchor Component	Component Material		
	Zinc Plated Carbon Steel	Type 303/304 Stainless Steel	Type 316 Stainless Steel
Anchor body	Meets minimum 70,000 psi tensile	AISI 303. Meets chemical requirements of ASTM A582	Type 316
Expander plug	Meets minimum 50,000 psi tensile	AISI 303	Type 316
Thread	UNC/Coil-thread	UNC	UNC

Hollow Drop-In Internally Threaded Anchor

The Simpson Strong-Tie® Hollow Drop-In Anchor (HDIA) is an internally threaded, flush-mount expansion anchor for use in hollow materials such as CMU and hollow-core plank, as well as in solid base materials such as brick, normal-weight and lightweight concrete.

Features

- Suitable for suspending conduit, cable trays, pipe supports, fire sprinklers and suspended lighting into concrete
- Expansion design allows HDIA to anchor into CMU, hollow-core plank, brick, normal-weight concrete and lightweight concrete
- Internally threaded anchor allows for easy bolt removal

Codes: Factory Mutual 3053987
($\frac{3}{8}$ "– $\frac{1}{2}$ " diameter);

Underwriters Laboratories File Ex3605
($\frac{3}{8}$ "– $\frac{1}{2}$ " diameter)

Material: Die-cast Zamac 3 alloy shell with carbon-steel cone or 304 stainless-steel cone



Hollow Drop-In Anchor (HDIA)



Hollow Drop-In Anchor

Size (in.)	Model No.	Drill Bit Diameter (in.)	Threads (per in.)	Overall Anchor Length (in.)	Quantity	
					Package Qty.	Carton Qty.
1/4	HDIA25	3/8	20	3/4	100	1,600
1/4	HDIA25SS	3/8	20	3/4	100	1,600
5/16	HDIA31	5/8	18	1 1/4	50	200
3/8	HDIA37	5/8	16	1 1/4	50	200
3/8	HDIA37SS	5/8	16	1 1/4	50	200
1/2	HDIA50	3/4	13	1 3/4	50	200
5/8	HDIA62	1	11	2	25	125

Hollow Drop-In Internally Threaded Anchor

HDIASTH Setting Tool for Hollow Materials

Setting tool designed to set the Hollow Drop-In internally threaded anchor in hollow materials such as CMU and hollow-core plank.

Model No.	Description	Size (in.)	Carton Qty.
HDIASTH25	Setting tool for use with Hollow Drop-In models HDIA25, HDIA25SS	¼	25
HDIASTH31	Setting tool for use with Hollow Drop-In model HDIA31	⅝	25
HDIASTH37	Setting tool for use with Hollow Drop-In models HDIA37, HDIA37SS	¾	25
HDIASTH50	Setting tool for use with Hollow Drop-In model HDIA50	½	25
HDIASTH62	Setting tool for use with Hollow Drop-In model HDIA62	⅝	10



**HDIASTH
Setting Tool**

1. Tools sold separately. Tools may be ordered by the piece.

HDIASTS Setting Tool for Solid Materials

Setting tool designed to set the Hollow Drop-In internally threaded anchor in solid materials such as brick, normal-weight and lightweight concrete.



HDIASTS Setting Tool

Model No.	Description	Size (in.)	Box Qty.	Carton Qty.
HDIASTS25	Setting tool for use with Hollow Drop-In models HDIA25, HDIA25SS	¼	25	125
HDIASTS31-37	Setting tool for use with Hollow Drop-In models HDIA31, HDIA37, HDIA37SS	⅝ – ¾	10	50
HDIASTS50	Setting tool for use with Hollow Drop-In model HDIA50	½	10	50
HDIASTS62	Setting tool for use with Hollow Drop-In model HDIA62	⅝	5	20

1. Tools sold separately. Tools may be ordered by the piece.

Hollow Drop-In Internally Threaded Anchor

Installation Instructions:

Solid Base (using solid setting tool)

- Drill a hole in the base material using the appropriate diameter carbide drill bit as specified in the table. Drill the hole to the specified embedment depth.
- Blow the hole clean using compressed air. Overhead installations need not be blown clean.
- Insert the HDIA into hole. Tap with hammer until flush against surface.
- Using the designated setting tool, drive the anchor to the bottom of the drilled hole. After the anchor reaches the bottom of the drilled hole, perform an additional three hammer blows against the setting tool to drive the anchor body over the cone.
- Position fixture; insert fastener and tighten.

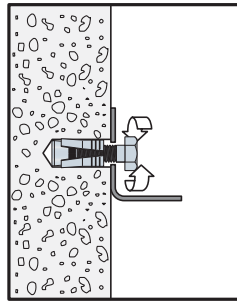
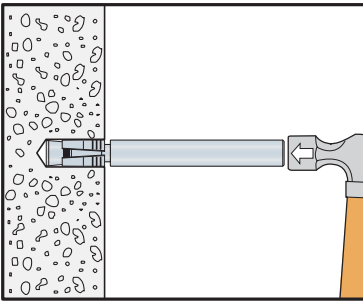
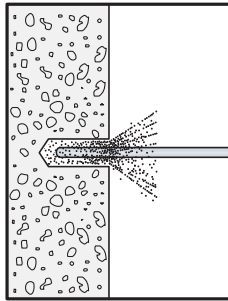
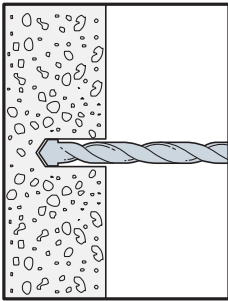

Hollow Drop-In Internally Threaded Anchor

Installation Instructions:

Hollow Base (using hollow setting tool)

- Drill a hole in the base material using the appropriate diameter carbide drill bit as specified in the table.
- Thread the HDIA onto the designated setting tool for hollow base materials.
- Insert the HDIA into the hole. Tap the setting tool until the face of the tool contacts the surface.
- Rotate the setting tool a minimum of two turns to set the anchor.
- Remove the setting tool.
- Position fixture; insert fastener and tighten.

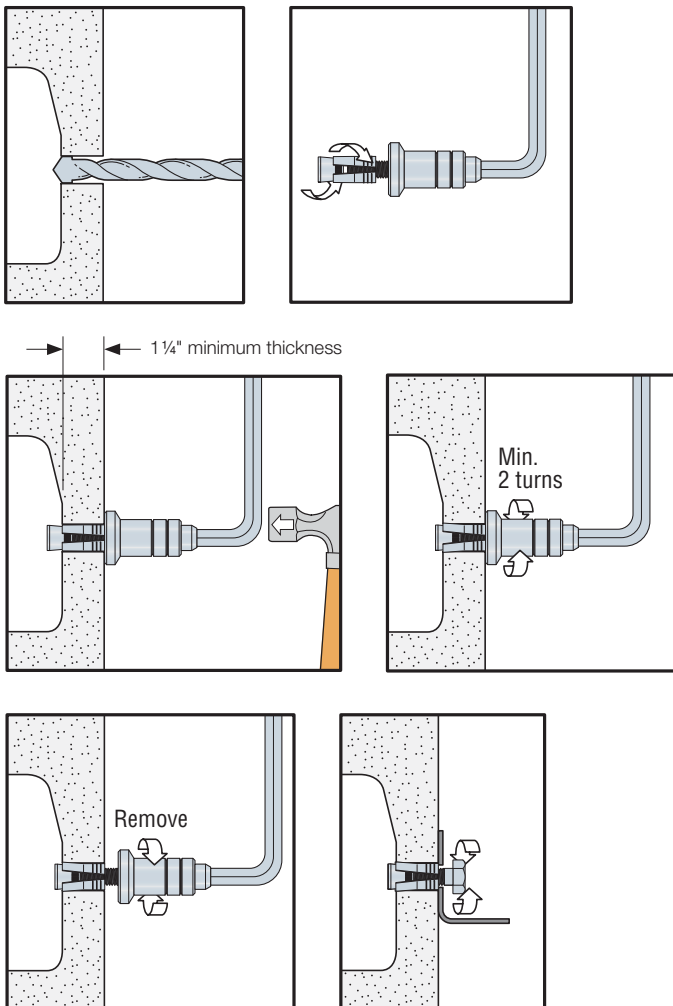

Zinc Nailon™ Pin Drive Anchors

Zinc Nailon anchors are low-cost, easy-to-install anchors for applications under static loads.

Features



- Available with carbon and stainless-steel pins
- Pin and head configuration designed to make anchor tamper-resistant

Code: Meets Federal Specification A-A-1925A, Type 1

Materials

- Body — Die-cast Zamac 3 alloy
- Pin — Carbon steel; Type 304 stainless steel

Installation

-  **Caution:** Not for use in overhead applications.
-  **Caution:** Nailon anchors are not recommended for eccentric tension (prying) loads — capacity will be greatly reduced in such applications

1. Drill a hole in base material using a carbide drill bit the same diameter as the nominal diameter of the anchor to be installed. Drill the hole to specified embedment depth, plus ¼" for pin extension, and blow hole clean using compressed air. Alternatively, drill the hole deep enough to accommodate embedment depth and dust from drilling.
2. Position fixture and insert Nailon anchor.
3. Tap with hammer until flush with fixture, then drive pin until flush with top of head.



Zinc Nailon Anchor
(mushroom)

Installation Sequence

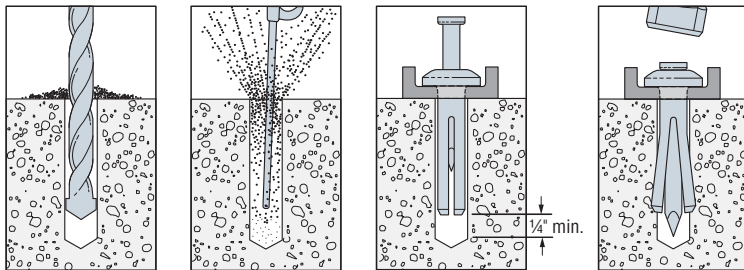

Zinc Nailon™ Pin Drive Anchors

Zinc Nailon Product Data

Size (in.)	Carbon Steel Pin Model No.	Stainless-Steel Pin Model No.	Quantity		
			Box	Carton	Bulk
3/16 x 7/8	ZN18078	—	100	1,600	3,000
1/4 x 3/4	ZN25034	ZN25034SS	100	500	2,000
1/4 x 1	ZN25100	ZN25100SS	100	500	1,500
1/4 x 1 1/4	ZN25114	ZN25114SS	100	500	1,500
1/4 x 1 1/2	ZN25112	ZN25112SS	100	500	1,000
1/4 x 2	ZN25200	ZN25200SS	100	400	1,000
1/4 x 2 1/2	ZN25212	ZN25212SS	100	400	1,000
1/4 x 3	ZN25300	ZN25300SS	100	400	1,000

Crimp Drive® Anchor

The crimp anchor is an easy-to-install expansion anchor for use in concrete and grout-filled block. The pre-formed curvature along the shaft creates an expansion mechanism that secures the anchor in place and eliminates the need for a secondary tightening procedure. This speeds up anchor installation and reduces the overall cost.

Five crimp anchor head styles are available to handle different applications that include fastening wood or light-gauge steel, attaching concrete formwork, hanging overhead support for sprinkler pipes or suspended ceiling panels.

Codes: Factory Mutual 3031 136 for the $\frac{3}{8}$ " rod coupler.

Material: Carbon steel, stainless steel

Coating: Zinc plated and mechanically galvanized

Head Styles: Mushroom, rod coupler, countersunk, tie-wire and duplex

Installation

Warning: Industry studies show that hardened fasteners can experience performance problems in wet or corrosive environments. Accordingly, with the exception of the duplex anchor, use these products in dry, interior and non-corrosive environments only.

1. Drill a hole using the specified diameter carbide bit into the base material to a depth of at least $\frac{1}{2}$ " deeper than the required embedment.
2. Blow the hole clean of dust and debris using compressed air. Overhead application need not be blown clean. Where a fixture is used, drive the anchor through the fixture into the hole until the head sits flush against the fixture.
3. Be sure the anchor is driven to the required embedment depth. The rod coupler and tie-wire models should be driven in until the head is seated against the surface of the base material.



Mushroom
Head



Rod
Coupler



Countersunk
Head



Tie-Wire



Duplex

Crimp Drive® Anchor

Installation Sequence

Rod Coupler

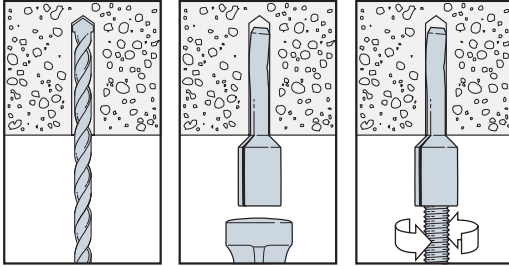

Tie-Wire

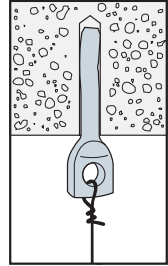

Mushroom Head

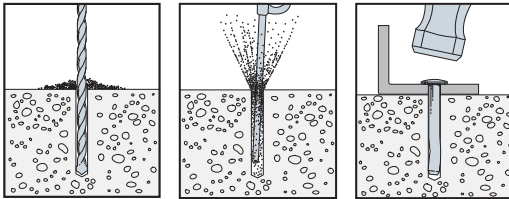

Duplex

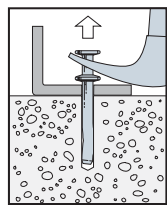

Duplex-head anchor may be removed with a claw hammer.

Countersunk Head Installation Sequence

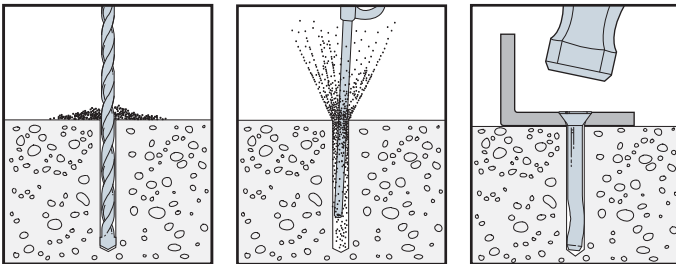

Length Identification Head Marks on Mushroom, Countersunk and Duplex-Head Crimp Drive Anchors (corresponds to length of anchor — inches)

Mark	□	A	B	C	D	E	F
From	1	1½	2	2½	3	3½	4
Up to but Not Including	1½	2	2½	3	3½	4	4½

Crimp Drive® Anchor

Crimp Drive Anchor Product Data

Size (in.)	Model No.	Head Style/Finish	Drill Bit Dia. (in.)	Min. Fixture Hole Size (in.)	Min. Embed. (in.)	Quantity			
						Pkg. Qty.	Carton Qty.		
3/16 x 1 1/4	CD18114M	Mushroom head / zinc plated	3/16	1/4	7/8	100	1,600		
3/16 x 2	CD18200M				1 1/4	100	500		
3/16 x 2 1/2	CD18212M				1 1/4	100	500		
3/16 x 3	CD18300M				1 1/4	100	500		
3/16 x 3 1/2	CD18312M				1 1/4	100	500		
3/16 x 4	CD18400M				1 1/4	100	500		
1/4 x 1	CD25100M		Mushroom head / zinc plated	1/4	5/16	7/8	100	1,600	
1/4 x 1 1/4	CD25114M					7/8	100	1,600	
1/4 x 1 1/2	CD25112M					1 1/4	100	1,600	
1/4 x 2	CD25200M					1 1/4	100	500	
1/4 x 2 1/2	CD25212M					1 1/4	100	500	
1/4 x 3	CD25300M					1 1/4	100	500	
1/4 x 3 1/2	CD25312M					1 1/4	100	500	
1/4 x 4	CD25400M					1 1/4	100	500	
3/8 x 2	CD37200M	3/8				7/16	1 3/4	25	125
3/8 x 3	CD37300M						1 3/4	25	125
1/4 x 3	CD25300MG	Mushroom head / mechanically galvanized	1/4	5/16	1 1/4	100	500		
1/4" rod coupler	CD25114RC	Rod coupler / zinc plated	3/16	N/A	1 1/4	100	500		
3/8" rod coupler	CD37112RC		1/4	N/A	1 1/2	50	250		
3/16 x 2 1/2	CD18212C	Countersunk head / zinc plated	3/16	1/4	1 1/4	100	500		
3/16 x 3	CD18300C				1 1/4	100	500		
3/16 x 4	CD18400C				1 1/4	100	500		
1/4 x 1 1/2	CD25112C		1/4	5/16	1 1/4	100	500		
1/4 x 2	CD25200C				1 1/4	100	500		
1/4 x 2 1/2	CD25212C				1 1/4	100	500		
1/4 x 3	CD25300C				1 1/4	100	500		
1/4 x 3 1/2	CD25312C				1 1/4	100	400		
1/4 x 4	CD25400C				1 1/4	100	400		
1/4 x 3	CD25300CMG				Countersunk head / mechanically galvanized ¹	1/4	5/16	1 1/4	100
1/4 x 4	CD25400CMG	1 1/4	100	400					
1/4" Tie Wire	CD25118T	Tie Wire / zinc plated	1/4	N/A	1 1/8	100	500		
1/4" duplex	CD25234D	Duplex head / zinc plated	1/4	5/16	1 1/4	100	500		

1. Mechanical galvanizing meets ASTM B695, Class 55, Type 1. Intended for some pressure-treated wood sill plate applications. Not for use in other corrosive or outdoor environments. See strongtie.com for details.

CSD/DSD Split-Drive Anchors

The Split-Drive anchor is a one-piece expansion anchor that can be installed in concrete, grout-filled block and stone. As the anchor is driven in, the split-type expansion mechanism on the working end compresses and exerts force against the walls of the hole.

Features

- Available in countersunk (CSD) and duplex-head (DSD) styles
- DSD anchor can be removed with a claw hammer for temporary applications

Material: Carbon steel

Coating: Zinc plated; mechanically galvanized

Installation



Warning (CSD only): Industry studies show that hardened fasteners can experience performance problems in wet or corrosive environments. Accordingly, use these products in dry, interior and non-corrosive environments only.



Caution: Oversized holes in the base material will greatly reduce the anchor's load capacity. For CSD, embedment depths greater than 1 1/2" may cause bending during installation.

1. Drill a hole in base material using a 1/4"-diameter carbide-tipped drill. Drill hole to specified embedment depth and blow clean using compressed air. (Overhead installation need not be blown clean.) Alternatively, drill hole deep enough to accommodate embedment depth and dust from drilling. Position fixture and insert split-drive anchor through fixture hole.
2. For CSD, 3/8"-diameter fixture hole is recommended for hard fixtures such as steel. For DSD, 5/16"-diameter fixture hole is recommended.
3. Drive anchor until head is flush against fixture.



DSD
(duplex)



CSD
(countersunk)

CSD/DSD Split-Drive Anchors

Installation Sequence

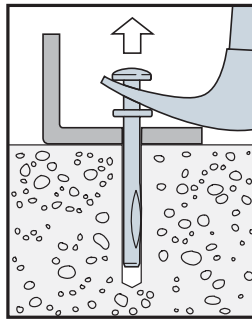
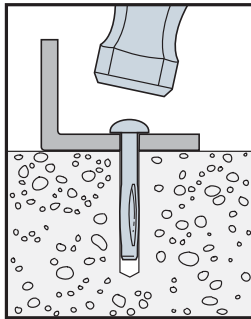
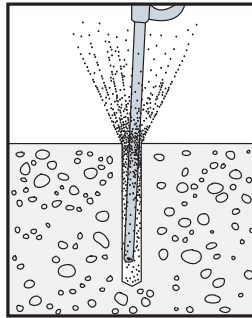
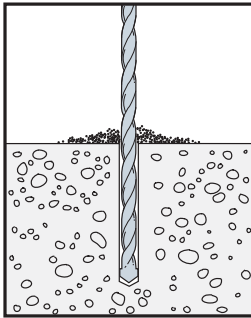

DSD anchor may be removed with a claw hammer.

CSD/DSD Product Data

Size (in.)	Model No.	Head Style / Finish	Drill Bit Diameter (in.)	Quantity	
				Box	Carton
¼ x 1½	CSD25112	Countersunk head – zinc plated	¼	100	500
¼ x 2	CSD25200			100	500
¼ x 2½	CSD25212			100	500
¼ x 3	CSD25300			100	400
¼ x 3½	CSD25312			100	400
¼ x 4	CSD25400			100	400
¼ x 3	CSD25300MG	Countersunk head – mechanically galvanized ¹	¼	100	400
¼ x 4	CSD25400MG			100	400
¼ x 3	DSD25300	Duplex head – zinc plated	¼	100	400

1. Mechanical galvanizing meets ASTM B695, Class 55, Type 1. Intended for some preservative-treated wood sill plate applications. Not for use in other corrosive or outdoor environments. See strongtie.com for details.

Sure Wall Drywall Anchor

Sure Wall anchors are self-drilling drywall anchors and provide excellent holding value and greater capacity than screws alone. This anchor cuts threads into drywall, greatly increasing the bearing surface and strength of the fastening.

Features

- Self-drilling — may be installed in gypsum board drywall with only a screwdriver
- Easy to remove and reinstall

Material: Die-cast zinc or reinforced nylon



Sure Wall
Nylon

Sure Wall
Zinc

Sure Wall Product Data

Screw Size	Model No.		Style	Quantity		Applications
	Packaged with Screws	Packaged without Screws		Box	Carton	
#8 x 1¼"	SWN08LS-R100	SWN08L-R100	Nylon	100	500	¾", ½" drywall, ceiling tile
#8 x 1¼"	SWZ08LS-R100	SWZ08L-R100	Zinc	100	500	¾", ½", ⅜" drywall, plaster

Installation Sequence

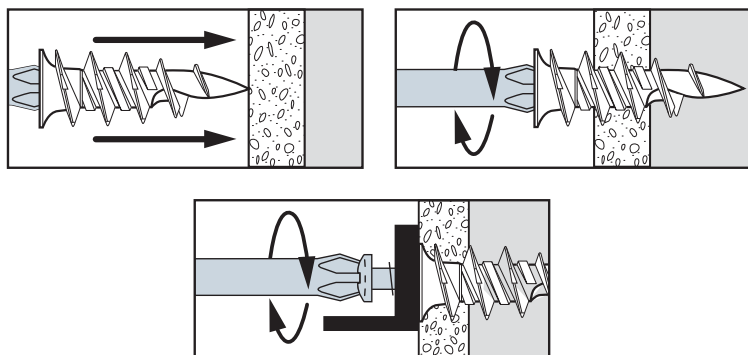



PTP-27L
Automatic
1/2" Spt
Made in Korea















SIMPSON
Strong-Tie

Direct Fastening Solutions



Powder-Actuated Tool / Fastener Suitability

This matrix matches Simpson Strong-Tie powder-actuated tools with the fasteners typically used with each tool.

Fasteners		General-Purpose Tools	
		PTP-27L 	
0.300"-Headed Fasteners with 0.157" Shank Diameter			
PDPA-XXX			✓
PDPAWL-XXX			✓
PDPAS-XXX			—
PDPAT-XXX			✓
PCLDPA-XXX			✓
PECLDPA-XXX			✓
PTRHA3-XXX			✓
0.300"-Headed Fasteners with 0.145" Shank Diameter			
PINW-XXX			✓
PINWP-XXX			✓
PHBC-XXX			✓
PCC-XXX			✓
PBXDP-100			✓
8 mm-Headed Fasteners			
PKP-250			✓
3/8"-Headed Fasteners / Threaded Studs			
PSLV3-XXX			—

See strongtie.com for more tool and fastener product information.

Powder-Actuated Tool / Fastener Suitability

✓ = Suitable
— = Not suitable

General-Purpose Tools		
PT-27 	PT-22A-RB 	PT-22HA-RB 
0.300"-Headed Fasteners with 0.157" Shank Diameter		
✓ Max. 2½"	✓	✓
✓	✓	✓
—	—	—
✓	✓	✓
✓	✓	✓
✓	✓	✓
✓	✓	✓
0.300"-Headed Fasteners with 0.145" Shank Diameter		
✓	✓	✓
✓	✓	✓
✓	✓	✓
✓	✓	✓
✓	✓	✓
8 mm-Headed Fasteners		
✓	✓	✓
⅜"-Headed Fasteners / Threaded Studs		
—	—	—

Gas Tool / Fastener Suitability

Direct Fastening Solutions

Gas Tool



GCN-MEPMAGKT

Fuel Cell



GFC34

0.106"- Diameter
Shank Pins



GDP

0.118"- /
0.102"- Diameter
Stepped-Shank
Pins



GDPS

Gas Tool / Fastener Suitability

Spiral
Knurl Pins



GDPSK

Mechanical,
Electrical,
Plumbing and
Ceiling Pins



GRH



GCL



GCT



GTS



GCC



GAC



GW



GTH

GCN-MEPMAGKT Gas-Actuated Concrete Nailer

The GCN-MEPMAGKT gas-actuated concrete nailer is a portable fastener tool used for attaching light-duty fixtures to concrete, steel, concrete block (CMU), lightweight concrete over metal deck and cold-formed steel. As a magazine tool, GCN-MEPMAGKT is ideal for attaching drywall track, furring strips, hat track and angle track using GDP and GDPS collated pins.

GCN-MEPMAGKT offers you the flexibility of having two tools in one convenient package — a magazine tool and a single-shot tool — since the magazine is easily removed without additional assembly tools. As a single-shot tool, the GCN-MEPMAGKT is great for attaching mechanical, electrical and plumbing fixtures with pre-assembled pins/accessories such as washer pins, ceiling clips, top hats and threaded studs. The pre-assembled pins for the single-shot tool use 0.283"-headed fasteners with 0.126"-diameter shanks for stronger fastening performance.

The tool used as a single-shot or with magazine offer portability without the need for cords or hoses, and are actuated with GFC34 gas fuel cells.

Features

- Power to drive 0.126"-diameter pins
- Flexibility to drive ½" to 1½" pins
- Flexibility to drive 0.250" and 0.286" diameter-headed pins
- Pin-depth adjustment dial
- Battery charge indicator light
- Comfortable "sure-grip" rubber handle and ladder hook
- Easy start-up procedure: Insert fuel cell, insert battery, load pins, and begin use



GCN-MEPMAGKT

Specifications

- Tool dimensions:
 - Length 12.5" (317.5 mm), 17" (432.8 mm)
 - Tool weight: 6.6 lb. (3 kg), 8.3 lb. (3.7 kg) with magazine
 - Height 15.3" (389 mm)
- Compatible fasteners:
 - Length: ½" (12.7 mm) to 1½" (38 mm)
 - Head diameter: 0.244" and 0.283"
 - Shank diameter: 0.106" to 0.128"
- Average number of shots per battery charge: 3,300
- Average number of shots per fuel cell: 1,200
- Average cyclic firing rate: 2 shots per second
- Average battery charge time (6V NiMH): 2 hours
- Operation temperature range: 20°–120°F (–6°–49°C)
- Magazine capacity: 42
- Maximum fastenings before reloading: 40

The magazine is designed to retain two pins during use to prevent the tool from discharging without a fastener (which can damage the tool and possibly cause injury). The tool will resume normal operation when additional pins are loaded.

GCN-MEPMAGKT Gas-Actuated Concrete Nail

Minimum Cleaning Required

The GCN-MEPMAGKT has a very efficient ignition system that provides complete fuel combustion. This results in a cleaner operating tool, which in turn results in more tool energy and higher productivity. To maintain maximum level of productivity, periodic cleaning is recommended.

- Only requires cleaning every 20,000 shots
- Easy access to the air filter and piston chamber

The GCN-MEPMAGKT gas-actuated concrete nailer is ideal for fastening:

- Drywall track
- Lath wire for stucco
- Water-proofing membrane
- Furring strips



GCN-MEPMAGKT

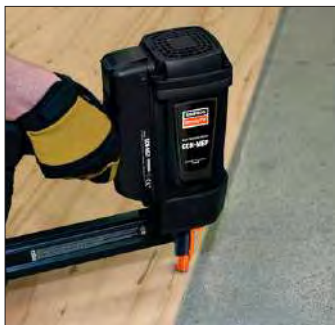

Gas-Actuated Concrete Nailing

GDP Pins

GDP concrete pins are designed to work with the GCN-MEPMAGKT gas-actuated concrete nailer as well as with many major brand gas-actuated concrete nailer tools. The patented 10-fastener strip is designed with breakaway plastic. The pins are designed for use in A36 and A572 steel, concrete, CMU block and sand-lightweight concrete over metal deck.



GDP
US Patent: 605,016

Codes: ICC-ES ESR-2811 (including City of LA Supplement); Florida FL-15730

GDP — 0.240"-Dia. ϕ Head with 0.106"-Dia. ϕ Shank Gas Drive Pins

Model No.	Pin		Quantity		Simpson Strong-Tie Tools
	Length (in.)	Shank Dia. (in.)	Pins per Pack + 1 Fuel Cell	Packs / Carton	
GDP-50KT	1/2	0.106	1,000	5	GCN-MEPMAGKT
GDP-62KT	5/8				
GDP-75KT	3/4				
GDP-100KT	1				
GDP-125KT	1 1/4				
GDP-150KT	1 1/2				

GDPS Pins

The GDPS pins are also designed to work in the GCN-MEPMAGKT gas-actuated nailer tool for installation into steel. The step-shank pin, with a smaller diameter tip, facilitates easier penetration, while the larger diameter upper shank provides more shear resistance and successful installation.



GDPS

Codes: ICC-ES ESR-2811 (including City of LA Supplement); Florida FL-15730

GDPS — 0.240"-Dia. ϕ Head with 0.118"/0.102"-Dia. ϕ Stepped-Shank Gas Drive Pins

Model No.	Pin		Quantity		Simpson Strong-Tie Tools
	Length (in.)	Shank Dia. (in.)	Pins per Pack + 1 Fuel Cell	Packs / Carton	
GDPS-50KT	1/2	0.118 / 0.102	1,000	5	GCN-MEPMAGKT
GDPS-62KT	5/8				
GDPS-75KT	3/4				

Gas-Actuated Concrete Nailing

Spiral Knurl Gas Pins

GDPSK gas pins are designed for attaching plywood and OSB to cold-formed steel studs. The spiral knurl provides a positive lock and resists back-out. Installed with the GCN-MEPMAGKT, the GDPSK-138 gas pin provides faster installation and setup times, which contributes to lower labor costs. The hardened pins quickly and cleanly pierce the cold-formed steel and leave the pin head flush with the wood fixture. The 1 3/8"-length pin can be used for 1/2"-3/4"-thick plywood, and 14-22 gauge steel.



GDPSK

GDPSK — 0.244"-Dia. ϕ Head with 0.106"-Dia. ϕ Shank Spiral Knurl Gas Drive Pins

Model No.	Pin		Quantity		Simpson Strong-Tie Tools
	Length (in.)	Shank Dia. (in.)	Pins per Pack + 1 Fuel Cell	Packs / Carton	
GDPSK-138KT	1 3/8	0.106	1,000	5	GCN-MEPMAGKT

GWL-100 Lathing Washer and GMR-2 Magnetic Ring

The GWL-100 lathing washer is used with the GCN-MEPMAGKT tool and attaches lath to the wall surface for overlaying scratch coats, brown coats and stucco. The washers are held onto the nose of the tool with the new GMR-2 magnetic ring and are attached to the substrate (including concrete and CMU) with GDP pins, which fasten through the washer. No extra tools are needed to install the magnetic ring to the nosepiece of the tool.



GWL-100

Lathing Washer and Magnetic Ring

Model No.	Description	Quantity	
		Pack	Carton
GWL-100	Lathing washer, 1" diameter	1,000	5,000
GMR-2	Magnetic ring for GCN-MEPMAGKT	1	900

Lathing washer and magnetic rings are sold separately.



GMR-2

Gas-Actuated Concrete Nailing

Fuel Cell

The GFC34 fuel cell is designed to operate with the GCN-MEPMAGKT and with many major-brand gas-actuated concrete nailer tools. The fuel cell provides 1,200 shots and can operate at temperatures between 20° and 120°F (–6°–49°C). The fuel cells are offered individually or in a two-per-pack clamshell. Additionally, one fuel cell is included with each pack of 1,000 pins.



GFC Fuel Cell

Gas Fuel Cells for the GCN-MEPMAGKT

Model No.	Description	Pack Quantity	Packs/ Carton	Simpson Strong-Tie Tool
GFC34	34-gram fuel cells	12	—	GCN-MEPMAGKT
GFC34-RC2	(2) 34-gram fuel cells	2	6	

Gas-Actuated Concrete Nailing

GCN-MEPMAGKT Gas-Actuated Pins and Assemblies for Mechanical, Electrical and Plumbing (MEP) and Ceiling Applications

Pre-assembled MEP and ceiling fasteners are available for use with the GCN-MEPMAGKT concrete nailer designed for high-volume applications, such as affixing conduit clips, rod hangers, cable ties and ceiling clips.

With their 0.283" heads, these versatile pins and assemblies can also be used with common powder-actuated tools when fastening into harder substrates (structural steel or extra-hard concrete) when required.

Codes: ICC-ES ESR-2811; Florida FL-15730



Mechanical, Electrical, Plumbing and Ceiling Gas-Actuated Pins

Model No.	Pin		Description	Pack Qty.	Simpson Strong-Tie Tools
	Diameter (in.)	Length (in.)			
GRH25-R100	0.126	1	1/4" – 20 threaded rod hanger (0.063" thick) with pin	100	GCN-MEPMAGKT
GRH37-R100	0.126	1	3/8" – 16 threaded rod hanger (0.063" thick) with pin	100	
GCC50-R100	0.126	1	1/2" conduit clip (0.047" thick) with pin	100	
GCC75-R100	0.126	1	3/4" conduit clip (0.059" thick) with pin	100	
GCC100-R100	0.126	1	1" conduit clip (0.059" thick) with pin	100	
GCC125-R50	0.126	1	1 1/4" conduit clip (0.071" thick) with pin	50	
GCL50-R50	0.126	1	1/2" conduit clamp (0.047" thick) with pin	50	
GCL75-R25	0.126	1	3/4" conduit clamp (0.047" thick) with pin	25	
GAC-R100	0.126	1	90° ceiling angle clip (0.071" thick) with pin	100	
GCT-R50	0.126	1	Tie-strap holder (0.0315" thick) with pin	50	
GW50-R200	0.128/ 0.110	1/2	1/2" dome washer stepped-shank pin	200	
GW75-R200	0.126	3/4	1/2" dome washer pin	200	
GW100-R100	0.126	1	1/2" dome washer pin	100	
GTS4-5075-R200	0.128	1 1/4	1/4" – 20 threaded stud (3/4" shank and 1/2" thread)	200	
GTH-R200	0.126	1	Top-Hat pin	200	

Extension Pole Tools

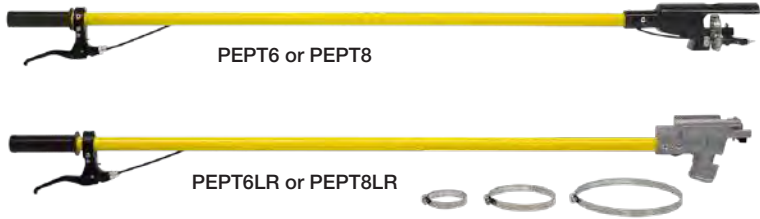

Advantages

- Available in 6' and 8' lengths
- Lightweight
- Eliminates need for scaffolding
- Rugged and durable design

Extension Poles for PT-27





Model No.	Description	Quantity
PEPT6	Complete 6' pole	1
PEPT8	Complete 8' pole	1

Extension Poles for PTP-27L, GCN-MEPMAGKT

Model No.	Description	Quantity
PEPT6LR	Complete 6' pole	1
PEPT8LR	Complete 8' pole	1

PAT Tool Matrix Powder-Actuated Fastening Systems

This matrix matches Simpson Strong-Tie powder-actuated tools with the trades that would typically use each tool. The selection is based upon the features of the tool matching the needs of the trade.

	Best	Better	Good	DIY
	PTP-27L	PT-27	PT-22A	PT-22HA
				
Features	<ul style="list-style-type: none"> • Automatic • Adjustable power • Low recoil • Low noise • Up to 3" pin length 	<ul style="list-style-type: none"> • Semi-automatic • Versatile • Reliable professional-grade tool • Up to 2 1/2" pin length (3" pin with washer) 	<ul style="list-style-type: none"> • Single shot • Economical professional-grade tool • Up to 3" pin length 	<ul style="list-style-type: none"> • Single shot • Hammer activated • Medium duty • Up to 3" pin length
Contractor / Trade				
Wood Framer	✓	✓	✓	✓
CFS Framer	✓	✓	✓	
MEP	✓	✓	✓	
Acoustics/ Overhead	✓	✓	✓	
Remodeling	✓	✓	✓	✓
DIY		✓	✓	✓

PTP-27L Premium Tool

The PTP-27L is a powder-actuated fastening tool designed to provide versatility and ease of use on the jobsite. This single-shot tool delivers productive fastening with automatic piston reset, which enables the user to simply load and shoot.



PTP-27L



Adjustable power increases versatility

Features

- Adjustable power for fastening versatility: 1–1½ power-level range from a single strip
- Easy disassembly for cleaning and maintenance
- No manual resetting of piston required
- Operator comfort: cushioned grip, reduced recoil and sound-dampening muffler for quiet operation

Key Fastening Applications

- Sill plate installation
- Washered pin installation
- Insulation fastening
- Forming work
- Drywall track and cold-formed steel installation

Specifications

- Fastener Length: ½"–3"
- Fastener Type: 0.300" (or 8 mm) diameter headed
- Firing Action: Automatic
- Load Caliber: 0.27 strip loads, brown through purple (levels 2–6)
- Length: 17¾"
- Weight: 6.5 lb.

PTP-27L Premium Tool

Tool is sold in a rugged tool box complete with

- Operator's manual
- Spall suppressor
- Tools for disassembly
- Safety glasses / ear plugs
- Cleaning brushes
- Operator's exam and caution sign
- Gloves
- Five replacement rubber returners



The full line of Simpson Strong-Tie powder loads and fasteners begins on p. 129.

Common Replacement Parts – PTP-27L

Part No.	Description
PTP-274810	Baseplate
PTP-273820	Fastener Guide
PTP-273320	Piston
PTP-273306	Piston Disc
PTP-274305	Rubber Returner

Complementary Products

Extension pole tools for the PTP-27L available in 6' and 8' lengths.



Extension pole tools for the PTP-27L — see p. 120 for details.

PT-27 General-Purpose Tool

The PT-27 is a semi-automatic and fast-cycling fastening tool that is engineered for continuous use, high reliability and low maintenance. This versatile tool fires a variety of fastener types and lengths.



PT-27

Key Fastening Applications

- Acoustical ceiling fixtures
- Electrical fixtures
- Sill-plate installation
- Drywall track and cold-formed steel installation
- Water proofing material and/or lathing

Specifications

- Fastener Length: ½"–2½"
(3" washered)
- Fastener Type: 0.300" or
8 mm-headed fasteners or
¼"-20 threaded studs
- Firing Action: Semi-automatic
- Load Caliber: 0.27 strip loads,
brown through red (levels 2–5)
- Length: 13½"
- Weight: 5 lb., 4 oz.

Tool is sold in a rugged tool box complete with

- Operator's manual
- Spall suppressor
- Tools for disassembly
- Safety glasses / ear plugs
- Cleaning brushes
- Operator's exam and
caution sign



The full line of Simpson Strong-Tie powder loads and fasteners begins on p. 129.

PT-27 General-Purpose Tool

Common Replacement Parts — PT-27

Part No.	Description
PT-301014	Annular spring
PT-301013	Ball bearing (6 mm)
PT-301006	Barrel
PT-301009	Baseplate
PT-301903	Piston — Flat (includes ring)
PT-301208	Piston ring
PT-301012	Piston stop
PT-301011	Shear clip
PT-27PK1	Normal wear part replacement kit
PT-MK1	Tool cleaning kit

For tool repair and maintenance kits, and complete tool schematics and parts list, visit strongtie.com.

Complementary Products

Extension pole tool for the PT-27 available in 6' and 8' lengths.



Extension pole tool for the PT-27 — see p. 120 for details.

PT-22A General-Purpose Tool

The PT-22A is a powder-actuated tool that uses 0.22 caliber "A" crimp loads, has single-shot firing action and is engineered for continuous use, high reliability and low maintenance.



PT-22A-RB

Key Fastening Applications

- Furring strips
- Framing pins
- Electrical boxes
- Ceiling clips

Specifications

- Fastener Length: 2½"
- Fastener Type: 0.300" or 8 mm-headed fasteners or ¼"–20 threaded studs
- Firing Action: Single shot
- Load Caliber: 0.22 single "A" crimp loads, brown through yellow (levels 2–4).
Note: Not for use with 0.22 caliber straight wall loads.
- Length: 13⅞"
- Weight: 4.4 lb.

PT-22A-RB Retail Package Product Data

Model No.	Description	Quantity	
		Tools per Retail Package	Retail Packages per Carton
PT-22A-RB	0.22 caliber, single-shot, trigger-activated tool	1	2

PT-22A General-Purpose Tool

Common Replacement Parts

Part No.	Description
PT22A-02	Piston buffer
PT22A-13	Piston reset cap
PT22A-11	Piston reset pin
PT22A-12	Piston reset spring
PT22A-03	Piston with ring

1. Complete tool schematics and parts list available at strongtie.com.



PT-22A-RB

The full line of Simpson Strong-Tie powder loads and fasteners begins on p. 129.

PT-22HA General-Purpose Tool

The PT-22HA is a hammer-activated tool engineered for low maintenance and economy. The tool offers three levels of power: Brown through yellow loads (levels 2–4).



PT-22HA-RB

Key Fastening Applications

- Remodeling
- Maintenance
- Electricians
- Telecommunications

Specifications

- Fastener Length: ½"–2 ½"
- Fastener Type: 0.300" or 8 mm-headed fasteners or ¼"–20 threaded studs
- Firing Action: Single shot, hammer activated
- Load Caliber: 0.22 single "A" crimp loads, brown through yellow (levels 2–4).
Note: Not for use with 0.22 caliber straight wall loads.
- Length: 14 ¼"
- Weight: 2 lb., 12 oz.



PT-22HA-RB Retail Package Product Data

Model No.	Description	Quantity	
		Tools per Retail Package	Retail Packages per Carton
PT-22HA-RB	0.22 caliber, single-shot, hammer-activated tool	1	4



The PT-22HA-RB comes packaged in a retail clamshell ready for merchandising.

Powder Loads for Powder-Actuated Tools

0.22 Caliber "A" Crimp Loads — Single Shot

Model No.	Caliber	Load		Quantity		Simpson Strong-Tie Tools
		Color	Level	Pack	Carton	
P22AC2	0.22	Brown	2	100	10,000	PT-22A PT-22HA
P22AC2A						
P22AC3	0.22	Green	3			
P22AC3A						
P22AC4	0.22	Yellow	4			
P22AC4A						



P22AC

Note: An "A" at the end of the model number denotes an imported load. No "A" indicates a domestic load.

0.25 Caliber Plastic 10-Shot Strip Loads

Model No.	Caliber	Load		Quantity	
		Color	Level	Pack	Carton
P25SL3	0.25	Green	3	100	10,000
P25SL4	0.25	Yellow	4		
P25SL5	0.25	Red	5		



P25SL

Powder Loads for Powder-Actuated Tools

0.27 Caliber Single-Shot Loads — Long

Model No.	Caliber	Load		Quantity	
		Color	Level	Pack	Carton
P27LVL4	0.27	Yellow	4	100	10,000
P27LVL5	0.27	Red	5		
P27LVL6	0.27	Purple	6		



P27LVL

0.27 Caliber Plastic 10-Shot Strip Loads

Model No.	Caliber	Load		Quantity		Simpson Strong-Tie Tools		
		Color	Level	Pack	Carton			
P27SL2	0.27	Brown	2	100	10,000	PTP-27L PT-27		
P27SL2A								
P27SL3	0.27	Green	3					
P27SL3A								
P27SL4	0.27	Yellow	4					
P27SL4A								
P27SL5	0.27	Red	5					
P27SL5A								
P27SL6	0.27	Purple	6					













Note: An "A" at the end of the model number denotes an imported load. No "A" indicates a domestic load.



P27SL

Fasteners for Powder-Actuated Tools

Simpson Strong-Tie powder-actuated drive pins are a hardened steel, designed to fasten building components to normal weight concrete, lightweight concrete, concrete over metal deck, steel and masonry. PDPA pins are designed to work with Simpson Strong-Tie powder-actuated tool systems as well as other common tools. The following is a chart of models, code listing, use and a page reference to product sku information.

Model		Code Listing		Use	Page
		ICC-ES	Florida		
PDPA		ESR-2138	FL-15730	Attachment of cold-formed steel or wood to structure	132
PDPAWL		ESR-2138	FL-15730	Attachment of cold-formed steel or wood to structure with additional bearing surface	132
PDPAS		ESR-2138	FL-15730	Attachment of cold-formed steel or wood to structure (collated pins)	133
PDPAT		ESR-2138	FL-15730	Attachment of cold-formed steel to structure with additional clamping	133
PCLDPA		ESR-2138	FL-15730	Attachment of suspended ceilings and overhead applications	133
PECLDPA		ESR-2138	FL-15730	Attachment of suspended ceilings and overhead applications	133
PTRHA		ESR-2138	FL-15730	Attachment of suspended ceiling, piping and other overhead items using threaded rod	134
PINW		ESR-2138	FL-15730	Attachment of insulation board (metal washers)	134
PINWP		ESR-2138	FL-15730	Attachment of insulation board (plastic washers)	134
PHBC		—	—	Attachment of rebar and dowel basket anchorage	135
PBXDP		—	—	Attachment of BX cables to structure	135
PCC		—	—	Attachment of conduits to structure	135
PSLV3		ESR-2138	FL-15730	Threaded support attachment to structure	135

Fasteners for Powder-Actuated Tools

PDPA — 0.300"-Dia. ϕ Head with
0.157"-Dia. ϕ Shank Powder Drive Pins

Model No.	Pin		Quantity		Simpson Strong-Tie Tools
	Length (in.)	Shank Dia. (in.)	Pack	Carton	
PDPA-50	1/2	0.157	100	1,000	PTP-27L PT-27 PT-22A PT-22HA
PDPA-50K	1/2 knurled				
PDPA-62K	5/8 knurled				
PDPA-75	3/4				
PDPA-100	1				
PDPA-106	1 1/16				
PDPA-125	1 1/4				
PDPA-131	1 5/16				
PDPA-150	1 1/2				
PDPA-187	1 7/8				
PDPA-200	2				
PDPA-250	2 1/2				
PDPA-250MG	2 1/2				
PDPA-287	2 7/8				
PDPA-287MG	2 7/8				



PDPA

Note: The PDPA-250MG and PDPD-287MG models have mechanically galvanized (Class 65) finish.

PDPAWL — 0.300"-Dia. ϕ Head with
0.157"-Dia. ϕ Shank Powder Drive Pins with 1" Washer

Model No.	Pin		Quantity		Simpson Strong-Tie Tools
	Length (in.)	Shank Dia. (in.)	Pack	Carton	
PDPAWL-50K	1/2 knurled	0.157	100	1,000	PTP-27L PT-27 PT-22A PT-22HA
PDPAWL-75	3/4				
PDPAWL-100	1				
PDPAWL-125	1 1/4				
PDPAWL-150	1 1/2				
PDPAWL-187	1 7/8				
PDPAWL-200	2				
PDPAWL-200MG	2				
PDPAWL-225	2 1/4				
PDPAWL-250	2 1/2				
PDPAWL-250MG	2 1/2				
PDPAWL-287	2 7/8				
PDPAWL-287MG	2 7/8				



PDPAWL

Note: The PDPAWL-200MG, PDPAWL-250MG and PDPAWL-287MG models have mechanically galvanized (Class 65) finish.

Fasteners for Powder-Actuated Tools

PDPAS — 0.300"-Dia. ϕ Head with
0.157"-Dia. ϕ Shank Powder Drive Pins (10-Pin Collation)

Model No.	Pin		Quantity		Simpson Strong-Tie Tools
	Length (in.)	Shank Dia. (in.)	Pack	Carton	
PDPAS-50K	½ knurled	0.157	100	1,000	—
PDPAS-62K	⅝ knurled				
PDPAS-75	¾				
PDPAS-100	1				
PDPAS-125	1¼				
PDPAS-150	1½				
PDPAS-187	1⅞				
PDPAS-200	2				
PDPAS-250	2½				
PDPAS-287	2⅞				



PDPAS

PDPAT — 0.300"-Dia. ϕ Head with
0.157"-Dia. ϕ Shank Powder Drive Pins with Top Hat

Model No.	Pin		Quantity		Simpson Strong-Tie Tools
	Length (in.)	Shank Dia. (in.)	Pack	Carton	
PDPAT-50K	½ knurled	0.157	100	1,000	PTP-27L PT-27 PT-22A PT-22HA
PDPAT-62KP	⅝ knurled				
PDPAT-75	¾				
PDPAT-100	1				



PDPAT

Note: PDPAT-62KP is a point protrusion pin. The point of the pin is designed to slightly protrude from the tool to aid in hole location.

Pre-Assembled Ceiling Clips — 0.300"-Dia. ϕ Head with
0.157"-Dia. ϕ Shank Powder Drive Pins

Model No.	Pin		Description	Quantity		Simpson Strong-Tie Tools
	Length (in.)	Shank Dia. (in.)		Pack	Carton	
PCL	—	—	90° 14 ga. ceiling clip angle (no pin)	100	1,000	—
PCLDPA-87	⅞	0.157	90° 14 ga. ceiling clip angle with pin	100	1,000	PTP-27L PT-27 PT-22A PT-22HA
PCLDPA-106	1⅞					
PCLDPA-131	1⅞					
PECLDPA-106	1⅞	0.157	120° 14 ga. ceiling clip angle with pin	100	1,000	
PECLDPA-131	1⅞					



PCL



PCLDPA



PECLDPA

Fasteners for Powder-Actuated Tools

Threaded Rod Hangers — 0.300"-Dia. ϕ Head with
0.157"-Dia. ϕ Shank Powder Drive Pins

Model No.	Pin		Thread Rod Hanger Size (Clip Gauge)	Quantity		Simpson Strong-Tie Tools
	Length (in.)	Shank Dia. (in.)		Pack	Carton	
PTRHA4-131	1 $\frac{5}{16}$	0.157	1/4" – 20 (14 ga.)	50	500	PTP-27L PT-27 PT-22A PT-22HA
PTRHA3-131			3/8" – 16 (14 ga.)			



PTRHA3

Insulation Board Attachment —
0.300"-Dia. ϕ Head with 0.145"-Dia. ϕ Shank Powder Drive Pins with 1 $\frac{7}{16}$ " Metal Washers

Model No.	Pin		Description	Quantity		Simpson Strong-Tie Tools
	Length (in.)	Shank Dia. (in.)		Pack	Carton	
PINW-150	1 $\frac{1}{2}$	0.145	Pin with 1 $\frac{7}{16}$ " metal washer	50	500	PTP-27L PT-27 PT-22A PT-22HA
PINW-200	2					
PINW-250	2 $\frac{1}{2}$					
PINW-300	3					



PINW

Insulation Board Attachment —
0.300"-Dia. ϕ Head with 0.145"-Dia. ϕ Shank
Powder Drive Pins with 1 $\frac{3}{8}$ " Plastic Washers

Model No.	Pin		Description	Quantity		Simpson Strong-Tie Tools
	Length (in.)	Shank Dia. (in.)		Pack	Carton	
PINWP-150W	1 $\frac{1}{2}$	0.145	Pin with 1 $\frac{3}{8}$ " white plastic washer	50	500	PTP-27L PT-27 PT-22A PT-22HA
PINWP-175W	1 $\frac{3}{4}$					
PINWP-200W	2					
PINWP-250W	2 $\frac{1}{2}$					
PINWP-300W	3					



PINWP

Fasteners for Powder-Actuated Tools

Pre-Assembled Highway Basket Clips —
0.300"-Dia. ϕ Head with 0.145"-Dia. ϕ Shank
Powder Drive Pins

Model No.	Pin		Description	Quantity		Simpson Strong-Tie Tools
	Length (in.)	Shank Dia. (in.)		Pack	Carton	
PHBC-150	1½	0.145	14 ga. highway basket attachment with pin	100	1,000	PTP-27L PT-27 PT-22A PT-22HA
PHBC-200	2			50	500	
PHBC-250	2½					



Pre-Assembled BX Cable and Conduit Straps —
0.300"-Dia. ϕ Head with 0.145"-Dia. ϕ Shank
Powder Drive Pins

Model No.	Pin		Description	Quantity		Simpson Strong-Tie Tools
	Length (in.)	Shank Dia. (in.)		Pack	Carton	
PBXDP-100	1	0.145	BX cable strap with pin	100	1,000	PTP-27L PT-27 PT-22A PT-22HA
PCC50-DP100	1	0.145	½" EMT conduit clip with pin	100	1,000	
PCC75-DP100			¾" EMT conduit clip with pin	50	500	
PCC100-DP100			1" EMT conduit clip with pin	50	500	



¾" – 16 x 1¼" Threaded Studs

Model No.	Pin		Description	Quantity		Simpson Strong-Tie Tools
	Shank Length (in.)	Shank Dia. (in.)		Pack	Carton	
PSLV3-12575K	¾ knurled	0.205	¾" – 16 x 1¼" threaded stud length	100	1,000	—
PSLV3-125100	1					
PSLV3-125125*	1¼					



*Indicates Factory Mutual Listing 3031724.

Fasteners for Powder-Actuated Tools

Concrete Forming Pin — 0.187"-Dia. ϕ Head with
0.145"-Dia. ϕ Shank Powder Drive Pins

Model No.	Pin		Quantity		Simpson Strong-Tie Tools
	Length (in.)	Shank Dia. (in.)	Pack	Carton	
PKP-250	2-7/16	0.145	100	1,000	PTP-27L PT-27 PT-22A PT-22HA



PKP

Miscellaneous

Hammer Drive Pin — 0.250"-Dia. ϕ Head with
0.140"-Dia. ϕ Shank Powder Drive Pins with
3/8" Metal Washer

Model No.	Pin		Quantity		Simpson Strong-Tie Tools
	Length (in.)	Shank Dia. (in.)	Pack	Carton	
PHD-75	3/4	0.140	100	1,000	PHT-38
PHD-100	1				
PHD-125	1 1/4				



PHD

Manual Hammer Tool

(not for use with powder loads)



PHT-38



Warning: Do not use powder loads with this tool. This is a hammer drive tool only. Use of powder loads with this tool may result in injury or death.

Gas- and Powder-Actuated Fastening Safety Principles

Before operating any Simpson Strong-Tie gas- or powder-actuated tool, you must read and understand the Operator's Manual and be trained by an authorized instructor in the operation of the tool. Simpson Strong-Tie highly recommends you read and fully understand the safety guidelines of the tool you use. You must then pass a test and receive a certified operator card to become a Certified Operator. The test and Operator's Manual are included with each tool kit, or certification can be obtained by taking the test online at strongtie.com.

GENERAL SAFETY

To avoid serious injury or death:

- ALWAYS make sure that the operator and bystanders wear safety glasses. Hearing and head protection are also recommended.
- ALWAYS post warning signs when gas- or powder-actuated tools are in use. Signs should state "Tool in Use" and should be posted within the area where the tool is being used.
- ALWAYS store gas- or powder-actuated tools unloaded. Tools, loads and gas cells should be stored in a locked container out of the reach of children.
- NEVER place any part of your body over the front muzzle of the tool even if no fastener is present. The fastener, pin or tool piston can cause serious injury or death in the event of an accidental discharge.
- NEVER transport fasteners or other hard objects in the same pocket or container with powder loads or fuel cells. These objects may strike the powder loads or puncture the fuel cell, thereby setting them off and causing serious injury or death.
- NEVER attempt to bypass or circumvent any of the safety features on a gas- or powder-actuated tool.
- ALWAYS keep the tool pointed in a safe direction.
- ALWAYS keep your finger off the trigger until ready to shoot.
- ALWAYS keep the tool unloaded until ready to use.

INSTALLATION SAFETY

To avoid serious injury or death:

- ALWAYS hold the tool perpendicular (90°) to the fastening surface to prevent ricocheting fasteners. Use the spall guard whenever possible.
- NEVER attempt to fasten to soft, thin, brittle or very hard materials such as drywall, light gauge steel, glass, tile or cast iron as these materials are inappropriate. Conduct a pre-punch test to determine base material adequacy.
- NEVER attempt to fasten to soft material like wood or drywall (fastening through soft materials into an appropriate base material may be allowed if the application is appropriate).
- NEVER attempt to fasten to a spalled, cracked or uneven surface.



Safety equipment, such as safety glasses and ear plugs, is recommended when using gas- or powder-actuated tools.



Restoration Solutions



CI-SLV Super-Low-Viscosity Injection Epoxy

CI-SLV super-low-viscosity structural injection epoxy is a two-component, high-modulus, high-solids, moisture-tolerant epoxy specially designed for pressure injection, gravity feeding and flood coat filling of concrete cracks when substrate temperatures are between 60°F (16°C) to 90°F (32°C). Available in 3-gallon bulk kits or convenient side-by-side cartridges dispensed through a static mixing nozzle using either a manual or pneumatic dispensing tool.

Features

- Chemically bonds with the concrete to provide a structural repair. CI-SLV seals the crack from moisture, protecting rebar in the concrete from corrosion.
- Moisture-tolerant, can be used on dry and damp surfaces
- Low surface tension allows the material to effectively penetrate narrow cracks
- Formulated for maximum penetration under pressure
- Non-shrink and resistant to oils, salts and mild chemicals
- Can be used with metered pressure-injection equipment
- Freeze-thaw resistant

Applications

- Pressure injection
- Gravity feed
- Underwater pressure injection
- Flood coat

Product Information

Mix Ratio/Type	2:1
Mixed Color	Clear
Crack Width	0.002" – 0.25" (0.05 mm – 6 mm)
Shelf Life	24 months
Storage Temperature	45°F (7°C) – 90°F (32°C)
Volatile Organic Compound (VOC)	8 g/L mixed
Yield	231 in. ³ /US gal. (0.001 m ³ /L)
For Flood-Coat Applications	150 – 200 ft. ² /US gal. (3.7 – 4.9 m ² /L) depending on surface profile and porosity
Pot Life, 1 Quart	6 minutes at 90°F (32°C) 25 minutes at 72°F (22°C)
Thin Film (5 mil)	Set to touch: 4 hrs.
Cure Time at 72°F, ASTM D5895	Dry through: 9 hrs.
Manufactured in the USA using global materials	



CI-SLV

CI-SLV Super-Low-Viscosity Injection Epoxy**Code Reports, Standards and Compliance**

ASTM C881 and AASHTO M235

Type I/IV; Grade 1; Class C

Installation Instructions

Installation instructions are located on pp. 157–165 and on the CI-SLV Technical Data Sheet at strongtie.com/rps.

CI-SLV Packaging Information

Model No.	Capacity (ounces)	Packaging Type	Package Quantity	Carton Quantity	Dispensing Tools	Mixing Nozzle
CISLV32 ¹	32	Side-by-side cartridge	1	5	ADT30S, ADT30P	EMN022
CISLV3KT	384	3 gallon bulk kit	1 case of (3) gallon cans	—	Metering pumps offered by third-party manufacturers	—

1. One EMN022 mixing nozzle supplied with each cartridge.
2. Cartridge estimation guidelines are available at strongtie.com/apps.

CI-LV Low-Viscosity Injection Epoxy

CI-LV low-viscosity structural injection epoxy is a two-component, high-modulus, high-solids, moisture-tolerant epoxy specially designed for pressure injection, gravity feeding and flood coat filling of concrete cracks and for increasing the bond between freshly placed repair mortars or concrete mixes and existing concrete when substrate temperatures are between 40°F (4°C) to 90°F (32°C). Available in 3-gallon bulk kits or convenient side-by-side cartridges dispensed through a static mixing nozzle using either a manual or pneumatic dispensing tool.

Features

- Chemically bonds with the concrete to provide a structural repair. CI-LV seals the crack from moisture, protecting rebar in the concrete from corrosion.
- Approved under NSF/ANSI Standard 61 (568 in.² /1,000 gal.)
- Moisture-tolerant, can be used on dry and damp surfaces
- Low surface tension allows the material to effectively penetrate narrow cracks
- Formulated for maximum penetration under pressure
- Non-shrink and resistant to oils, salts and mild chemicals
- Can be used with metered pressure-injection equipment
- Freeze-thaw resistant

Applications

- Pressure injection
- Underwater pressure injection
- Gravity feed
- Flood coat
- Repair mortar
- Bonding agent



CI-LV

Product Information

Mix Ratio/Type	2:1
Mixed Color	Dark amber
Crack Width	0.002" – 0.25" (0.05 mm – 6 mm)
Shelf Life	24 months
Storage Temperature	45°F (7°C) – 90°F (32°C)
Base Material Temperature	40°F (4°C) – 90°F (32°C)
Volatile Organic Compound (VOC)	2 g/L mixed
Yield	231 in. ³ /US gal. (0.001 m ³ /L)
For Flood-Coat Applications	150 – 200 ft. ² /US gal. (3.7 – 4.9 m ² /L) depending on surface profile and porosity
Pot Life, 1 Quart	10 minutes at 90°F (32°C) 25 minutes at 72°F (22°C) 100 minutes at 50°F (10°C)
Thin Film (5 mil)	Set to touch: 3 hrs. 50 min.
Cure Time at 72°F, ASTM D5895	Dry through: 6 hrs. 15 min.
Manufactured in the USA using global materials	

CI-LV Low-Viscosity Injection Epoxy**Code Reports, Standards and Compliance**

ASTM C881 and AASHTO M235

Type I/II; Grade 1; Class B,

Type I/IV and II/IV, Grade 1, Class C

NSF/ANSI/CAN 61 (216 in.² / 1,000 gal.)**Installation Instructions**

Installation instructions are located on pp. 157–165 and on the CI-LV Technical Data Sheet at strongtie.com/rps.

CI-LV Packaging Information

Model No.	Capacity (ounces)	Packaging Type	Package Quantity	Carton Quantity	Dispensing Tools	Mixing Nozzle
CILV32 ¹	32	Side-by-side cartridge	1	5	ADT30S, ADT30P	EMN022
CILV3KT	384	3 gallon bulk kit	1 case of (3) gallon cans	—	Metering pumps offered by third-party manufacturers	—

1. One EMN022 mixing nozzle supplied with each cartridge.

2. Cartridge estimation guidelines are available at strongtie.com/apps.

CI-LV FS Low-Viscosity Fast-Setting Injection Epoxy

CI-LV FS fast-setting low-viscosity structural injection epoxy is a two-component, high-modulus, high-solids, moisture-tolerant epoxy specially designed for pressure injection of concrete cracks and for increasing the bond between freshly placed repair mortars or concrete mixes and existing concrete when substrate temperatures are between 40°F (4°C) to 90°F (32°C). Available in 3-gallon bulk kits or convenient side-by-side cartridges dispensed through a static mixing nozzle using either a manual, battery-powered or pneumatic dispensing tool.

Features

- Chemically bonds with the concrete to provide a structural repair. CI-LV FS seals the crack from moisture, protecting rebar in the concrete from corrosion.
- Moisture-tolerant, can be used on dry and damp surfaces
- Low surface tension allows the material to effectively penetrate narrow cracks
- Formulated for maximum penetration under pressure
- Non-shrink and resistant to oils, salts and mild chemicals
- Can be used with metered pressure-injection equipment
- Freeze-thaw resistant

Applications

- Pressure injection
- Gravity feed
- Bonding agent
- Underwater pressure injection
- Flood coat

**CI-LV FS****Product Information**

Mix Ratio/Type	2:1
Mixed Color	Amber
Crack Width	0.016" – 0.25" (0.4 mm – 6 mm)
Shelf Life	24 months
Storage Temperature	45°F (7°C) – 90°F (32°C)
Base Material Temperature	40°F (4°C) – 90°F (32°C)
Volatile Organic Compound (VOC)	13 g/L mixed
Yield	231 in. ³ /US gal. (0.001 m ³ /L)
For Flood-Coat Applications	150 – 200 ft. ² /US gal. (3.7 – 4.9 m ² /L) depending on surface profile and porosity
Pot Life, 1 Quart	10 minutes at 72°F (22°C) 28 minutes at 50°F (10°C)
Thin Film (5 mil)	Set to touch: 1 hr. 45 min.
Cure Time at 72°F, ASTM D5895	Dry through: 4 hrs.
Manufactured in the USA using global materials	

CI-LV FS Low-Viscosity Fast-Setting Injection Epoxy**Code Reports, Standards and Compliance**

ASTM C881 and AASHTO M235

Type I/II; Grade 1; Class B,

Type I/IV and II/V, Grade 1, Class C

Installation Instructions

Installation instructions are located on pp. 157–165 and on the CI-LV FS Technical Data Sheet at strongtie.com/rps.

CI-LV FS Packaging Information

Model No.	Capacity (ounces)	Packaging Type	Package Quantity	Carton Quantity	Dispensing Tools	Mixing Nozzle
CILVFS32 ¹	32	Side-by-side cartridge	1	5	ADT30S, ADT30P	EMN022
CILVFS3KT	384	3 gallon bulk kit	1 case of (3) gallon cans	—	Metering pumps offered by third-party manufacturers	—

1. One EMN022 mixing nozzle supplied with each cartridge.
2. Cartridge estimation guidelines are available at strongtie.com/apps.

CI-LPL Low-Viscosity Long-Pot-Life Injection Epoxy

CI-LPL long-pot-life structural injection epoxy is a two-component, high-modulus, high-solids, moisture-tolerant epoxy specially designed for pressure injection, gravity feeding and flood coat filling of concrete cracks when substrate temperatures are between 60°F (16°C) to 110°F (43°C). Available in 3-gallon bulk kits or convenient side-by-side cartridges dispensed through a static mixing nozzle using either a manual or pneumatic dispensing tool.

Features

- Chemically bonds with the concrete to provide a structural repair. CI-LPL seals the crack from moisture, protecting rebar in the concrete from corrosion.
- Moisture-tolerant, can be used on dry and damp surfaces
- Formulated for use in hot environments to 110°F
- Low surface tension allows the material to effectively penetrate narrow cracks
- Formulated for maximum penetration under pressure
- Non-shrink and resistant to oils, salts and mild chemicals
- Can be used with metered pressure-injection equipment
- Freeze-thaw resistant

Applications

- Pressure injection
- Gravity feed
- Underwater pressure injection



CI-LPL

Product Information

Mix Ratio/Type	2:1
Mixed Color	Amber
Crack Width	0.016" – 0.25" (0.4 mm – 6 mm)
Shelf Life	24 months
Storage Temperature	45°F (7°C) – 90°F (32°C)
Base Material Temperature	60°F (16°C) – 110°F (43°C)
Volatile Organic Compound (VOC)	< 1 g/L mixed
Yield	231 in. ³ /US gal. (0.001 m ³ /L)
For Flood-Coat Applications	150 – 200 ft. ² /US gal. (3.7 – 4.9 m ² /L) depending on surface profile and porosity
Pot Life, 1 Quart	20 minutes at 90°F (32°C) 60 minutes at 72°F (22°C)
Thin Film (5 mil) Cure Time at 72°F, ASTM D5895	Set to touch: 6 hrs. 30 min. Dry through: 16 hrs. 30 min.
Thin Film (5 mil) Cure Time at 95°F, ASTM D5895	Set to touch: 3 hrs. Dry through: 4 hrs.
Manufactured in the USA using global materials	

CI-LPL Low-Viscosity Long-Pot-Life Injection Epoxy**Code Reports, Standards and Compliance**

ASTM C881 and AASHTO M235

Type I/IV; Grade 1; Class C

Installation Instructions

Installation instructions are located on pp. 157–165 and on the CI-LPL Technical Data Sheet at strongtie.com/rps.

CI-LPL Packaging Information

Model No.	Capacity (ounces)	Packaging Type	Package Quantity	Carton Quantity	Dispensing Tools	Mixing Nozzle
CILPL32 ¹	32	Side-by-side cartridge	1	5	ADT30S, ADT30P	EMN022
CILPL3KT	384	3 gallon bulk kit	1 case of (3) gallon cans	—	Metering pumps offered by third-party manufacturers	—

1. One EMN022 mixing nozzle supplied with each cartridge.
2. Cartridge estimation guidelines are available at strongtie.com/apps.

CI-GV Gel-Viscosity Injection Epoxy

CI-GV structural injection epoxy gel is a two-component, high-modulus, high-solids, moisture-tolerant, thixotropic epoxy designed for pressure injection of concrete cracks. CI-GV is suitable for vertical and horizontal crack sealing and general concrete repair applications when substrate temperatures are between 40°F (4°C) to 90°F (32°C). Available in 3-gallon bulk kits or convenient side-by-side cartridges dispensed through a static mixing nozzle using either a manual or pneumatic dispensing tool.

Features

- Chemically bonds with the concrete to provide a structural repair. CI-GV seals the crack from moisture, protecting rebar in the concrete from corrosion.
- Gel-viscosity moisture-tolerant, can be used on dry and damp surfaces
- Formulated for maximum penetration under pressure
- Non-shrink and resistant to oils, salts and mild chemicals
- Can be used with metered pressure-injection equipment
- Freeze-thaw resistant

Applications

- Pressure injection
- Repair mortar
- Pick proof sealant
- Underwater pressure injection
- Bonding agent



CI-GV

Product Information

Mix Ratio/Type	2:1
Mixed Color	Concrete gray
Crack Width	0.094" – 0.25" (2.4 mm – 6 mm)
Shelf Life	24 months
Storage Temperature	45°F (7°C) – 90°F (32°C)
Base Material Temperature	40°F (4°C) – 90°F (32°C)
Volatile Organic Compound (VOC)	10 g/L mixed
Yield	231 in. ³ /US gal. (0.001 m ³ /L)
Pot Life, 1 Quart	8 minutes at 90°F (32°C) 19 minutes at 72°F (22°C) 55 minutes at 50°F (10°C)
Thin Film (5 mil)	Set to touch: 3 hrs.
Cure Time at 72°F, ASTM D5895	Dry through: 6 hrs.
Manufactured in the USA using global materials	

CI-GV Gel-Viscosity Injection Epoxy**Code Reports, Standards and Compliance**

ASTM C881 and AASHTO M235

Type I/II; Grade 3; Class B,

Type I/IV and II/IV, Grade 3, Class C

Installation Instructions

Installation instructions are located on pp. 157–165 and on the CI-GV Technical Data Sheet at strongtie.com/rps.

CI-GV Packaging Information

Model No.	Capacity (ounces)	Packaging Type	Package Quantity	Carton Quantity	Dispensing Tools	Mixing Nozzle
CIGV32 ¹	32	Side-by-side cartridge	1	5	ADT30S, ADT30P	EMNO22
CIGV3KT	384	3 gallon bulk kit	1 case of (3) gallon cans	—	Metering pumps offered by third-party manufacturers	—

1. One EMNO22 mixing nozzle supplied with each cartridge.
2. Cartridge estimation guidelines are available at strongtie.com/apps.

Crack-Pac® Injection Epoxy

The Crack-Pac injection epoxy is designed to repair cracks in concrete ranging from 1/64" to 1/4" wide in concrete walls, floors, slabs, columns and beams. The mixed adhesive has the viscosity of a light oil and a low surface tension, allowing it to penetrate fine to medium-width cracks in dry, damp or wet conditions with excellent results. Resin is contained in the cartridge and hardener is contained in the nozzle.

Features

- Dispenses with a standard caulking tool, no special dispensing tool needed
- Clean and easy to mix
- Seals out moisture, protecting rebar in the concrete from corrosion and flooring from moisture damage
- Chemically bonds with the concrete to restore strength
- Non-shrink material resistant to oils, salts and mild chemicals
- Meets the requirements of AASHTO M235 and ASTM C881, Type I, Grade 1, Class C

Application Considerations

- Suitable for repair of cracks ranging from 1/64" to 1/4" wide in concrete walls, floors, slabs, columns and beams.
- Can be used to inject cracks in dry, damp or wet conditions with excellent results. Not for use in actively leaking cracks.
- In order for components to mix properly, the resin and hardener must be conditioned to 60°F (16°C) to 80°F (27°C) before mixing.

Shelf Life

24 months from date of manufacture, when stored between 45°F (7°C) and 90°F (32°C) in unopened cartridge.

Base Material Temperature

60°F (16°C) to 90°F (32°C).

Installation Instructions

Installation instructions are located on pp. 157–165.



Crack-Pac
Injection Epoxy
(ETIPAC10)

Crack-Pac® Injection Epoxy



**Crack-Pac Kit
(ETIPAC10KT)**

Crack-Pac injection epoxy is also available in the Crack-Pac Injection Kit (ETIPAC10KT). The kit includes everything needed to pressure inject cracks.

- 2 Crack-Pac cartridge/nozzle sets (ETIPAC10)
- 12 E-Z-Click™ injection ports
- 2 E-Z-Click injection fittings with 12" tubing
- 1 pint of ETR paste-over epoxy (8 oz. of resin + 8 oz. of hardener)
- 4 disposable wood paste-over applicators
- 1 pair latex gloves

Crack-Pac Cartridge System

Model No.	Capacity (ounces)	Cartridge Type	Carton Quantity	Dispensing Tool
ETIPAC10	9	Single	12	CDT10S
ETIPAC10KT	18	Single	2 (kits)	

Crack-Pac® Flex-H₂O™ Polyurethane Crack Sealer

The Crack-Pac Flex-H₂O polyurethane injection resin seals leaking cracks, voids or fractures from 1/32" to 1/4" wide in concrete or solid masonry. Designed to perform in applications where water is seeping or mildly leaking from the crack, the polyurethane is packaged in the cartridge and an accelerator is packaged in the nozzle. When the resin encounters water as it is injected into the crack, it becomes an expanding foam that provides a flexible seal in leaking and non-leaking cracks.

Features

- Can be dispensed with a standard caulking tool
- Can also be used on dry cracks if water is introduced to affected area
- Can be used with a reduced amount or without accelerator to slow down reaction time
- Expands to fill voids and seal the affected area
- Fast reacting — reaction begins within 1 minute after exposure to moisture; expansion may be completed within 3 minutes (depending on the amount of moisture and the ambient temperature)
- 20:1 expansion ratio (unrestricted rise) means less material needed

Application Considerations

- Suitable for sealing cracks ranging from 1/32" to 1/4" wide in concrete and solid masonry.
- Suitable for repair of cracks in dry, damp and wet conditions with excellent results. Designed to perform in applications where water is seeping or mildly leaking from the crack.
- In order for components to mix properly, the resin and hardener must be conditioned to 60°F (16°C) to 90°F (32°C) before mixing.

Shelf Life

12 months from the date of manufacture, when stored between 45°F (7°C) and 90°F (32°C) in unopened cartridge. Product is very moisture sensitive.

Base Material Temperature

60°F (16°C) to 90°F (32°C).

Installation Instructions

Installation instructions are located on pp. 157–165.



**Crack-Pac Flex-H₂O
Crack Sealer
(CPFH09)**

Crack-Pac® Flex-H₂O™ Polyurethane Crack Sealer

Crack-Pac Flex-H₂O Kit
(CPFH09KT)

Crack-Pac Flex-H₂O injection epoxy is also available in the Crack-Pac Flex-H₂O Injection Kit (CPFH09KT). The kit includes everything needed to pressure inject cracks.

- 2 Crack-Pac Flex-H₂O cartridge/nozzle sets (CPFH09)
- 12 E-Z-Click™ injection ports
- 2 E-Z-Click injection fittings with 12" tubing
- 1 pint of ETR paste-over epoxy (8 oz. of resin + 8 oz. of hardener)
- 4 disposable wood paste-over applicators
- 1 pair latex gloves

Crack-Pac Flex-H₂O Packaging

Model No.	Capacity	Cartridge Type	Carton Quantity	Dispensing Tool
CPFH09	9 ounces	Single	12	CDT10S
CPFH09KT	18 ounces	Single	2 (kits)	
FH05 ¹	5 gallons resin	Pail	1	—
	16 ounces catalyst			

1. For standard reaction time, use 30:1 resin to catalyst ration.
For a faster reaction time, add more catalyst; for a slower reaction time, use less.

CIP / ETR Paste-Over and Crack Sealants

CIP and ETR are fast-curing epoxy used to paste-over and seal cracks while securing injection ports to the surface of concrete substrates prior to injecting an epoxy or urethane crack repair product. When properly mixed, the products will be a uniform gray color and can be left in place or removed after the repair is complete.

Features

- 1:1 two component, high solids, epoxy amine based adhesive
- Non-sag paste consistency for horizontal, vertical or overhead applications
- Manufactured in the USA using global materials

CIP-LO Low Odor Paste-Over Epoxy and Crack Sealant

- Low odor formulation
- Strong substrate bond; requires chipping to remove
- Gel Time — 6 minutes at 72°F (22°C), 28 minutes at 40°F (4°C)
- Cure Time — 75 minutes at 72°F (22°C), 2 hours at 60°F (16°C) and 4–5 hours at 40°F (4°C)
- Volatile organic compound (VOC) — 4 g/L

CIP-F Flexible Paste-Over Adhesive and Crack Sealant

- Remains flexible after cure for easier removal
- Moderate substrate bond; peels away for removal
- Gel Time — 4 minutes at 72°F (22°C), 9 minutes at 40°F (4°C)
- Cure Time — 1 hour at 72°F (22°C), and 3 hours at 40°F (4°C)
- Volatile organic compound (VOC) — 0 g/L



CIP-LO



CIP-F

CIP / ETR Paste-Over and Crack Sealants

ETR Concrete Repair and Paste-Over Epoxy

- Canisters are mixed manually and do not require dispensing tool
- Each package contains enough material to cover approximately eight lineal feet of cracks
- Gel Time — 6 minutes at 72°F (22°C), 10 minutes at 40°F (4°C)
- Cure Time — 1 hour at 72°F (22°C), 2 hours at 60°F (16°C)
- Volatile organic compound (VOC) — 7 g/L
- Available in two 8 fl. oz. canisters



ETR16

Application Considerations

- Apply to concrete 40°F (4°C) or above. For best results, warm material to 65°F (16°C) or above prior to application.

Shelf Life

24 months from date of manufacture, unopened for CIP-LO and ETR;
12 months from date of manufacture, unopened for CIP-F.

Storage Conditions

For best results, store between 45°F (7°C) and 90°F (32°C)
for CIP-LO and ETR; 60°F (16°C) – 95°F (35°C) for CIP-F.

Installation Instructions

Installation instructions are located on pp. 157–160.

Paste-Over and Crack Sealants

Model No.	Capacity (oz.)	Cartridge	Mixing Nozzle	Dispensing Tool	Package Quantity	Carton Quantity
CIPLO22 ¹	22	Side-by-side	EMN22I	EDT22S, ETA22CKT, ETA22P	1	10
CIP-F22 ²	22	Side-by-side	EMNCIPF22		1	10
ETR16	16	—	—	—	1	4

1. One EMN22I mixing nozzle supplied with each cartridge.
2. One EMNCIPF22 mixing nozzle supplied with each cartridge.

Crack Repair Accessories



EMN022 Optimix®
Mixing Nozzle

Mixing Nozzles

Model No.	Description	Package Quantity	Carton Quantity
EMNCIPF22-RP5	Mixing nozzle for CIPF-22 epoxy	5	5
EMN022-RP6	Optimix mixing nozzle for epoxies	6	5

1. Use only appropriate Simpson Strong-Tie mixing nozzle in accordance with Simpson Strong-Tie instructions. Modification or improper use of mixing nozzle may impair epoxy performance.
2. Includes retaining nuts.



E-Z-Click™
Ports and Injection Fitting

EIPX-EZ
Corner-Mount/
Drilled-In Port

EIP-EZA
Flush-Mount
Port

Injection Ports and Injection Fittings

Model No.	Description	Hole Size (in.)	Package Contents		Carton Quantity
			Ports	E-Z-Click Injection Fitting	
EIP-EZAKT	E-Z-Click flush-mount injection ports	—	20	1	5 kits
EIP-EZA		—	1 each	—	100
EIPX-EZKT	E-Z-Click corner mount or drill in injection port	5/8	20	1	5 kits
EIPX-EZ-RP20			20	—	5 packs of 20
EIF-EZ	E-Z-Click injection fitting	—	—	1 each	10

1. EIPX intended for use as a surface-mount port in corners and as a drilled-in port on flat surfaces.

Detailed information on the full line of Simpson Strong-Tie manual, battery and pneumatic dispensing tools can be found on pp. 28–29 and is available on strongtie.com.

Crack Injection Guide



Important: These instructions are intended as recommended guidelines. Due to the variability of field conditions, selection of the proper material for the intended application and installation is the sole responsibility of the applicator.

Epoxy injection is an economical method of repairing non-moving cracks in concrete walls, slabs, columns and piers and is capable of restoring the concrete to its pre-cracked strength. Prior to doing any injection it is necessary to determine the cause of the crack. If the source of cracking has not been determined and remedied, the concrete may crack again.

Materials

- CI-LV and CI-SLV for repair of hairline cracks (0.002") and those up to 1/4" in width.
- CI-LV FS and CI-LPL for repair of fine to medium-width cracks (suggested width range: 1/64"–1/4").
- CI-GV for repair of medium-width cracks (suggested width range: 3/32"–1/4").
- Crack-Pac® injection epoxy for repair of fine to medium non-structural cracks (suggested width range: 1/64"–1/4").
- Crack-Pac Flex-H2O™ polyurethane crack sealer for repair of fine- to medium-width non-structural cracks (suggested width range: 1/32"–1/4").
- CIP-LO, CIP-F and ETR are recommended for paste-over of crack surface and installation of injection ports. ET-HP may also be used as a substitute.
- E-Z-Click™ injection ports, fittings and other suitable accessories.

Crack Injection Guide

Estimating Guide for Epoxy Crack Injection

Width of Crack (in.)	Concrete Thickness (in.)	CI-SLV, CI-LV, CI-LV FS, CI-LPL, CI-GV	ETI-LV, ETI-GV	ETI-SLV	Crack-Pac	Crack-Pac Flex-H ₂ O
		Approx. Coverage per 32 oz. Cartridge (linear ft.)	Approx. Coverage per 22 oz. Cartridge (linear ft.)	Approx. Coverage per 16.5 oz. Cartridge (linear ft.)	Approx. Coverage per 9 oz. Cartridge (linear ft.)	Approx. Coverage per 9 oz. Cartridge (linear ft.)
1/64	4	69.4	47.7	35.7	18.4	—
	6	46.3	31.8	23.8	12.3	—
	8	34.6	23.8	17.9	9.2	—
	10	27.8	19.1	14.3	7.4	—
1/32	4	34.6	23.8	17.9	9.2	108.0
	6	23.1	15.9	11.9	6.1	72.0
	8	17.3	11.9	8.9	4.6	54.0
	10	13.8	9.5	7.1	3.7	43.2
1/16	4	17.3	11.9	8.9	4.6	54.0
	6	11.5	7.9	6.0	3.1	36.0
	8	8.7	6.0	4.5	2.3	27.0
	10	7.0	4.8	3.6	1.8	21.6
1/8	4	8.7	6.0	4.5	2.3	27.0
	6	5.8	4.0	3.0	1.5	18.0
	8	4.4	3.0	2.2	1.2	13.5
	10	3.5	2.4	1.8	0.9	10.8
3/16	4	5.8	4.0	3.0	1.5	18.0
	6	3.8	2.6	2.0	1.0	12.0
	8	2.9	2.0	1.5	0.8	9.0
	10	2.3	1.6	1.2	0.6	7.2
1/4	4	4.4	3.0	2.2	1.2	13.5
	6	2.9	2.0	1.5	1.8	9.0
	8	2.2	1.5	1.1	0.6	6.8
	10	1.7	1.2	0.9	0.5	5.4

Coverage listed is approximate and will vary depending on waste and condition of concrete.

Crack Injection Guide

Preparation of the Crack for Injection

Clean the crack and the surface surrounding it to allow the paste-over to bond to sound concrete. At a minimum, the surface to receive paste-over should be brushed with a wire brush. Oil, grease or other surface contaminant must be removed in order to allow the paste-over to bond properly. Take care not to impact any debris into the crack during cleaning. Using clean, oil-free compressed air, blow out the crack to remove any dust, debris or standing water. Best results will be obtained if the crack is dry at the time of injection. If water is continually seeping from the crack, the flow must be stopped in order for epoxy injection to yield a suitable repair. Other materials such as polyurethane resins may be required to repair an actively leaking crack.

For many applications, additional preparation is necessary in order to seal the crack. Where a surfacing material has been removed using an acid or chemical solvent, prepare the crack as follows:

1. Using clean, compressed air, blow out any remaining debris and liquid.
2. Remove residue by high-pressure washing or steam cleaning.
3. Blow any remaining water from the crack with clean compressed air.

If a coating, sealant or paint has been applied to the concrete, it must be removed before placing the paste-over epoxy. Under the pressure of injection, these materials may lift and cause a leak. If the surface coating is covering the crack, it may be necessary to route out the opening of the crack in a "V" shape using a grinder in order to get past the surface contamination.

Crack Injection Guide

Sealing of the Crack and Attachment of E-Z-Click™ Injection Ports

1. To adhere the port to the concrete, apply a small amount of paste-over around the bottom of the port base. Place the port at one end of the crack and repeat until the entire crack is ported. As a rule of thumb, injection ports should be placed 8" apart along the length of the crack.



Important: Do not allow paste-over to block the port or the crack under it, this is where epoxy must enter the crack.

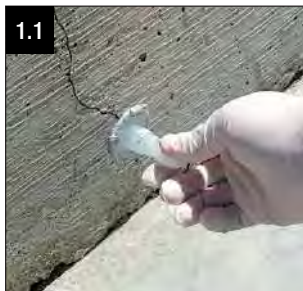

2. Using a putty knife or other paste-over tool, generously work paste-over along the entire length of the crack. Take care to mound the paste-over around the base of the port to approximately 1/4" thick extending 1" out from the base of the port and to work out any holes in the material. It is recommended that the paste-over should be a minimum of 3/16" thick and 1" wide along the crack. Insufficient paste-over will result in leaks under the pressure of injection. If the crack passes completely through the concrete element, seal the back of the crack, if possible. If not, injection epoxy may be able to run out the backside of the crack, resulting in an ineffective repair.

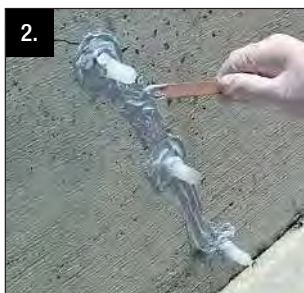

3. Allow the paste-over to harden before beginning injection.

Note: CIP-LO and ETR are a fast cure and when manually mixed may harden prematurely if left in a mixed mass on the mixing surface while installing ports. Spreading paste-over into a thin film (approximately 1/8") on the mixing surface will slow curing by allowing the heat from the reaction to dissipate.

Crack Injection Guide

Injection Procedure for CI-SLV, CI-LV, CI-LV FS, CI-LPL, CI-GV and Crack-Pac® Injection Epoxy

1. Follow cartridge preparation instructions on the cartridge label. Verify the material flowing from the Opti-Mix® mixing nozzle is a uniform and consistent color.
2. Attach the E-Z-Click™ fitting to the end of the nozzle by pushing the tubing over the barbs at the end of the nozzle. Make sure that all ports are pushed in to the open position.
3. Attach the E-Z-Click injection fitting to the first E-Z-Click port until it clicks into place. Make sure that the heads of all the ports are pushed in to the open position. In vertical applications, begin injection at the lowest port and work your way up. In a horizontal application start at one end of the crack and work your way to the other end.
4. Inject epoxy into the first port until it will no longer flow into the crack. If epoxy shows at the next port and the first port still accepts material, close the second port and continue to inject into the first port until it accepts no more epoxy. Continue closing ports where epoxy appears until the first port refuses epoxy. When the first port reaches the point of refusal, brace the base of the port and pull out gently on the head of the port to close it. Pulling too hard may dislodge the port from the surface of the concrete, causing a leak. Depress the metal tab on the head of the E-Z-Click fitting and remove it from the port.
5. Go to the last port where epoxy appeared while injecting the first port, open it, and continue injection at this port. If the epoxy has set up and the port is bonded closed, move to the next clean port and repeat the process until every portion of the crack has refused epoxy.

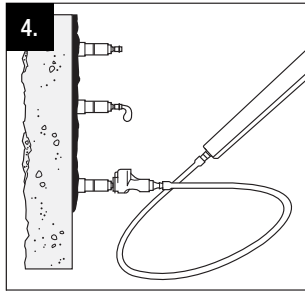

While this method may appear to leave some ports uninjected, it provides maximum pressure to force the epoxy into the smaller areas of the crack. Moving to the next port as soon as epoxy appears will allow the epoxy to travel along the wider parts of the crack to the next ports rather than force it into the crack before it travels to the next ports.

Crack Injection Guide

Injection Tips

- If using a pneumatic dispensing tool, set the tool at a low setting when beginning injection and increase pressure if necessary to get the epoxy to flow.
- For narrow cracks it may be necessary to increase the pressure gradually until the epoxy begins to flow. It may also be necessary to wait a few minutes for the epoxy to fill the crack and travel to the next port.
- If desired, once the injection epoxy has cured, remove the injection ports and paste-over. Epoxy paste-over can be removed with a chisel, scraper, or grinder. The paste-over can be simply peeled off if CIP-F is used. Using a heat gun to soften the epoxy is recommended when using a chisel or scraper.
- Mixing nozzles can be used for multiple cartridges as long as the epoxy does not harden in the nozzle. For injection epoxies in side-by-side cartridges, care must be taken to ensure the level of material is the same on both parts of the cartridge. This can be done by checking for air in the cartridge and the positions of the wipers in the back of the cartridge. If the liquid levels are off by more than $\frac{1}{8}$ ", then Step 1 from the injection procedures must be repeated.

Troubleshooting

Epoxy is flowing into the crack, but not showing up at the next port.

This most likely indicates that epoxy is running out of the unsealed backside of the crack. In this case the application may require a gel viscosity injection epoxy (CI-GV) or may not be suitable for epoxy injection repair without excavation and sealing of the backside of the crack.

This may also indicate that either the crack expands and/or branches off under the surface of the concrete. Continue to inject and fill these voids. In situations where the crack penetrates completely through the concrete element and the backside of the concrete element cannot be sealed (e.g., basement walls, or footings with backfill) longer injection time may not force the epoxy to the next port.

Epoxy is leaking from the pasted-over crack or around injection ports.

Stop injecting. If using a fast cure paste-over material (CIP-F, CIP-LO or ETR), wipe off the leaking injection epoxy with a cotton cloth and reapply the paste over material. Wait approximately 10 to 15 minutes to allow the paste-over to begin to harden. If the leak is large (e.g., the port broke off of the concrete surface) it is a good idea to wait approximately 30 minutes, or longer as necessary, to allow the paste over to cure more completely. Check to see that the paste-over is hard before reinjecting or the paste-over or ports may leak. Another option for small leaks is to clean off the injection epoxy and use paraffin or crayon to seal the holes.

More epoxy is being used than estimated.

This may indicate that the crack either expands or branches off below the surface. Continue to inject and fill these voids. This may also indicate that epoxy is running out of the backside of the crack. If the crack penetrates completely through the concrete element and cannot be sealed, the application may not be suitable for injection repair.

Crack Injection Guide

Troubleshooting (cont.)

Back pressure is preventing epoxy from flowing.

This can indicate several situations:

- The crack is not continuous and the portion being injected is full (see above instructions about injection after the port has reached refusal). See Step 4 on p. 161.
- The port is not aligned over the crack properly.
- The crack is blocked by debris.
- The injection epoxy used has too high a viscosity.
- If the mixing nozzle has been allowed to sit for a few minutes full of epoxy, the material may have hardened in the nozzle.

Attach the E-Z-Click™ fitting to a port at another uninjected location on the crack and attempt to inject. If the epoxy still won't flow, chances are the epoxy has hardened in the nozzle.

Less epoxy is being used than estimated.

This may indicate that the crack is shallower than originally thought, or the epoxy is not penetrating the crack sufficiently before moving to the next port. Reinject some ports with a lower viscosity epoxy to see if the crack will take more epoxy. Another option is to heat the epoxy to a temperature of 80–100°F which will reduce its viscosity and allow it to penetrate into small cracks easier. The epoxy should be heated uniformly, do not overheat cartridge.

Injection Procedure for Crack-Pac® Flex-H₂O™ Crack Sealer

1. Follow cartridge preparation instructions on the cartridge label. Verify that the material flowing from the nozzle is a uniform green color.
2. Attach the E-Z-Click fitting to the end of the nozzle by pushing the tubing over the barbs at the end of the nozzle. Make sure that all ports are pushed into the open position. If crack is dry, introduce a small amount of water (1–2 mL) into each open port using a dropper, pipet, syringe or squirt bottle.
3. Attach the E-Z-Click injection fitting to the first E-Z-Click port until it clicks into place. Make sure that the head of the port is pushed into the open position. In vertical applications, begin injection at the lowest port and work your way up. In a horizontal application, start at one end of the crack and work your way to the other end.
4. Inject polyurethane into the first port until material shows at the next port. Remove the E-Z-Click fitting by bracing the base of the port and pulling out gently on the head of the port to close it. Pulling too hard may dislodge the port from the surface of the concrete, causing a leak. Depress the metal tab on the head of the E-Z-Click fitting and remove it from the port.
5. Move to the next port and repeat until all ports have been injected.

Crack Injection Guide

Injection Tips for Crack-Pac® Flex-H₂O™ Crack Sealer

- For narrow cracks, it may be necessary to increase the pressure gradually until the polyurethane begins to flow. It may also be necessary to wait a few minutes for the material to fill the crack and travel to the next port.
- If desired, once the polyurethane has cured, remove the injection ports and paste-over. Epoxy paste-over can be removed with a chisel, scraper, or grinder. The paste-over can be simply peeled off if CIP-F is used. Using a heat gun to soften the epoxy is recommended when using a chisel or scraper.

Troubleshooting for Crack-Pac Flex-H₂O Crack Sealer

Polyurethane is flowing into the crack, but not showing up at the next port.

This can indicate several situations:

- That polyurethane is running out the unsealed backside of the crack.
- There is not enough water present to react with the polyurethane and generate foam.
- The crack either expands and/or branches off under the surface of the concrete.

Continue to inject and fill these voids. In situations where the crack penetrates completely through the concrete element, and the backside of the concrete element cannot be sealed (e.g., basement walls, or footings with backfill), longer injection time may not force the polyurethane to the next port. This most likely indicates that polyurethane is running out the unsealed backside of the crack. In this case, the application may require a gel viscosity injection epoxy (CI-GV) or may not be suitable for injection repair without excavation and sealing of the backside of the crack.

Back pressure is preventing polyurethane from flowing.

This can indicate several situations:

- The crack is not continuous and the portion being injected is full.
- The port is not aligned over the crack properly.
- The crack is blocked by debris.

Attach the E-Z Click™ fitting to the next uninjected port on the crack and continue the injection.

Polyurethane is leaking from the pasted-over crack or around injection ports.

Stop injecting. If using a fast cure paste-over material (CIP-F, CIP-LO or ETR), wipe off the leaking polyurethane with a cotton cloth and reapply the paste over material. Wait approximately 10–15 minutes to allow the paste-over to begin to harden. If the leak is large (e.g., the port broke off of the concrete surface), it is a good idea to wait approximately 30 minutes, or longer as necessary, to allow the paste-over to cure more completely. Check to see that the paste-over is hard before reinjecting or the paste-over or ports may leak.

Another option for small leaks is to clean off the injection adhesive and use paraffin or crayon to seal the holes.

Crack Injection Guide

Troubleshooting for Crack-Pac® Flex-H₂O™ Crack Sealer (cont.)

More polyurethane is being used than estimated.

This may indicate there is not enough water present to react with the polyurethane and generate foam. Introduce water into the port and continue to inject. Introduce water into subsequent ports prior to injection.

This may also indicate that the crack either expands or branches off below the surface. Continue to inject and fill these voids.

Less polyurethane is being used than estimated.

This may indicate that the crack is shallower than originally thought, or the polyurethane is not penetrating the crack sufficiently before moving to the next port.

Ensure polyurethane foam presents at the next injection port before moving to that port or fill the crack at the port until rejection.

Gravity-Feed Procedure

Some horizontal applications where complete penetration is not a requirement can be repaired using the gravity-feed method.

1. Follow cartridge preparation instructions on the cartridge label.
Verify that the material flowing from the Optimix® mixing nozzle is a uniform and consistent color.
2. Starting at one end of the crack, slowly dispense epoxy into the crack, moving along the crack as it fills. It will probably be necessary to do multiple passes in order to fill the crack. It is possible that the epoxy will take some time to run into the crack, and the crack may appear empty several hours after the initial application. Reapply epoxy until the crack is filled.
3. In situations where the crack completely penetrates the member (e.g., concrete slab), the material may continue to run through the crack into the subgrade. It may be possible to use a small amount of coarse, dry sand to act as a barrier for the injection epoxy. Place the sand in the crack to a level no more than ¼ the thickness of the member and apply the injection epoxy as described in step 2. The epoxy level will drop as it penetrates the sand, but should cure and provide a seal to the bottom of the crack. Reapply the epoxy until the crack is filled. In some cases, application of sand is impractical or not permitted and epoxy repair may not provide a complete and effective repair. Use of a gel viscosity injection epoxy (CI-GV) may permit a surface repair to the crack with partial penetration.

Heli-Tie™ Helical Wall Tie

The Heli-Tie helical wall tie is a stainless-steel tie used to anchor building façades to structural members or to stabilize brick walls.

The helical design allows the tie to be driven quickly and easily into a predrilled pilot hole (or embedded into mortar joints in new construction) to provide a mechanical connection between a masonry façade and its backup material. As it is driven, the fins of the tie undercut the masonry to provide an expansion-free anchorage that will withstand tension and compression loads.

The Heli-Tie wall tie is installed into a predrilled hole using a proprietary setting tool with an SDS-plus® shank rotohammer to drive and countersink the tie. Heli-Tie wall ties perform in concrete and masonry as well as wood and steel studs.



Heli-Tie Helical Wall Tie

US Patent: 7,269,987

Features

- Installs quickly and easily — with the rotohammer in hammer mode, the tie installs faster than competitive products.
- Provides an inconspicuous repair that preserves the appearance of the building. After installation, the tie is countersunk up to ½" below the surface, allowing the tie location to be patched.
- Larger core diameter provides higher torsional capacity, resulting in less deflection due to “uncoiling” under load.
- Fractionally sized anchor — no metric drill bits required.
- Patented manufacturing process results in a more uniform helix along the entire tie, allowing easier driving and better interlock with the substrate.

Material: Type 304 stainless steel (Type 316 available by special order — contact Simpson Strong-Tie for details)

Test Criteria: CSA A370



Heli-Tie™ Helical Wall Tie

Installation

- Drill pilot hole through the façade material and into the backup material to the specified embedment depth + 1" using appropriate drill bit(s) in the chart below. Drill should be in rotation-only mode when drilling into soft masonry or into hollow backing material.
- Position blue end of the Heli-Tie fastener in the installation tool and insert the tie into the pilot hole.
- With the SDS-plus® rotohammer in hammer mode, drive the tie until the tip of the installation tool enters the exterior surface of the masonry and countersinks the tie below the surface. Patch the hole in the façade with a matching masonry mortar.

Heli-Tie Helical Wall Tie Product Data

Size (in.)	Model No.	Drill Bit Diameter (in.)	Quantity	
			Box	Carton
¾ x 7	HELI37700A	7/32 or ¼	50	400
¾ x 8	HELI37800A		50	400
¾ x 9	HELI37900A		50	400
¾ x 10	HELI371000A		50	200
¾ x 11	HELI371100A		50	200
¾ x 12	HELI371200A		50	200
¾ x 14	HELI371400A		50	200
¾ x 16	HELI371600A		50	200
¾ x 18	HELI371800A		50	200
¾ x 20	HELI372000A		50	200

Special-order lengths are also available; contact Simpson Strong-Tie for details.

Heli-Tie™ Design Information

Installation Sequence

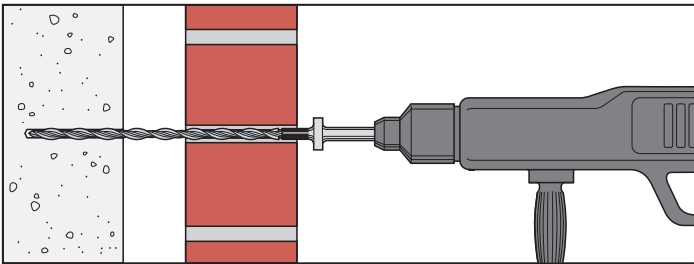
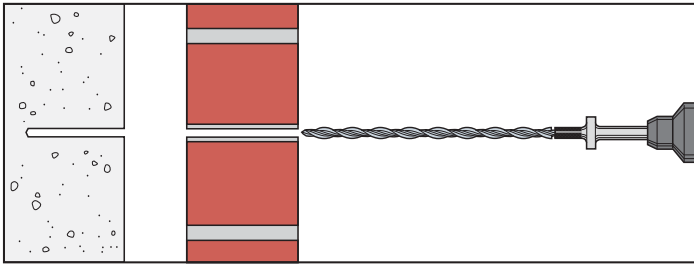
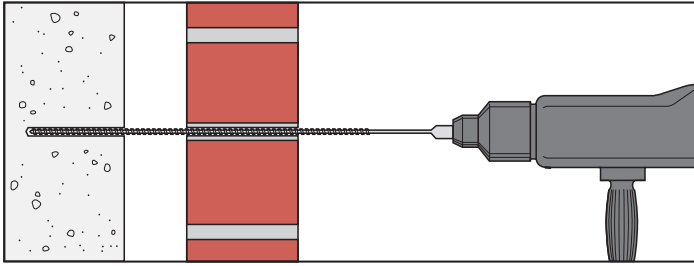

Restoration Solutions



Watch how to install Heli-Tie helical wall ties at strongtie.com/videolibrary.

Heli-Tie™ Accessories**Heli-Tie Fastener Installation Tool —
Model HELITool37A**

Required for correct installation of Heli-Tie wall ties. Speeds up installation and automatically countersinks the tie into the façade material.



HELITool37A

**Heli-Tie Wall Tie Tension Tester —
Model HELITEST37A**

Recommended equipment for onsite testing to accurately determine load values in any specific structure, the Heli-Tie wall tie tension tester features a key specifically designed to grip the Heli-Tie fastener and provide accurate results. Replacement test keys sold separately (Model HELIKEY37A).

Contact Simpson Strong-Tie for Heli-Tie onsite testing procedures.



HELITEST37A



HELIKEY37A

For more information see strongtie.com/helitie.

Heli-Tie™ Helical Stitching Tie

The Simpson Strong-Tie® Heli-Tie helical stitching tie provides a unique solution to the preservation and repair of damaged brick and masonry structures. Ties are grouted into existing masonry joints to repair cracks and increase strength with minimum disturbance. Made of Type 304 stainless steel, the Heli-Tie stitching tie features radial fins formed on the steel wire via cold rolling process, increasing the tensile strength of the tie.



HELIST254000

Features

- Helical design distributes loads uniformly over a large surface area
- Installs into the mortar joint to provide an inconspicuous repair and preserve the appearance of the structure
- Type 304 stainless steel offers superior corrosion resistance to mild steel reinforcement
- Patented manufacturing process results in consistent, uniform helix configuration (US Patent: 7,269,987)
- Batch number printed on each tie for easy identification and inspection

HELIST254000: ¼" x 40" stitching tie
(special lengths are available upon request)

Material: Type 304 stainless steel

Ordering Information: Sold in tubes of 10

Installation Instructions

- Chase bed joint 20" on either side of the affected area to a depth of approximately 1 ¼" with a rotary grinding wheel. Vertical spacing of installation sites should be 12" for red brick or "every other course" for concrete masonry units.
- Clear bed joint of all loose debris.
- Mix non-shrink repair grout or mortar per product instructions and place into the prepared bed joint, filling the void to approximately two-thirds of its depth. Simpson Strong-Tie RPS-263 Rapid-Hardening Vertical / Overhead Repair Mortar should be used.
- Embed the tie at one-half the depth of the void. Trowel displaced grout to fully encapsulate the tie.
- Fill any remaining voids and vertical cracks with non-shrink repair grout or other repair mortar to conceal repair site.

Heli-Tie™ Helical Stitching Tie

Installation Sequence

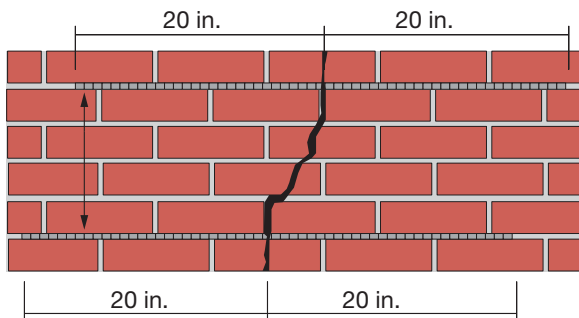
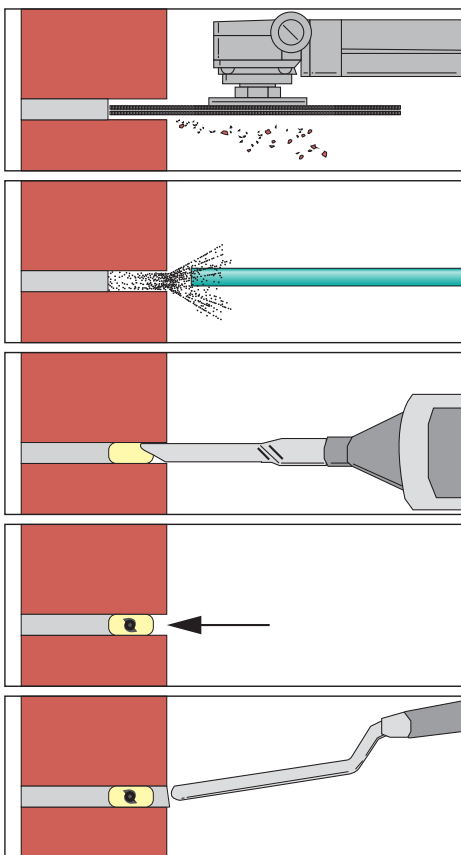

Watch how to install Heli-Tie helical wall ties at strongtie.com/video library.



Smarter
Strengthening
Solutions



A Strong Alliance for Stronger Structures

Through their alliance, Simpson Strong-Tie and Structural Technologies offer one-stop, end-to-end concrete and masonry strengthening and repair solutions with the best products, installation and support available.

Integrated Design-Build Solutions

Simpson Strong-Tie, a leading provider of tested, code-listed, high-performance products and technical services for the construction industry, and Structural Technologies, a renowned provider of state-of-the-art infrastructure strengthening solutions and engineering support services, have formed a strategic alliance within North America.

This new alliance enables both companies to jointly deliver complete end-to-end repair and strengthening solutions to engineering professionals, general contractors and owners across multiple construction and repair markets. The combination of innovative products, design support, engineering partners and contracting services allows us to deliver fully integrated design-build solutions from initial problem investigation through final installation.

SIMPSON

Strong-Tie

struc'tural
TECHNOLOGIES

Simpson Strong-Tie offers decades of innovative engineer-supported products, cutting-edge testing capabilities, relentless customer service and dedicated field-engineering support.

Structural Technologies brings their deep industry knowledge, solutions, design support and technical services, along with licensed installers, to the alliance.

Together, we offer a uniquely integrated scope of technical knowledge and solutions for concrete and masonry strengthening and repair that ultimately better serves your needs and helps ensure stronger, safer, longer-lasting structures.

One End-to-End Solution. Twice the Expertise.

- Design, engineering and specification services
- Innovative product solutions
- Advanced testing capabilities
- Expert installation and maintenance service by licensed installers
- Dedicated customer service and onsite field engineers

Let us help you find the right solution for your project and budget. For additional information, visit strongtie.com/alliance or call (800) 999-5099 to discuss your project with a local field engineer.



CSS V-Wrap™ Composite Strengthening Systems™

CSS Solutions

CSS enhances the strength of existing structural elements which require additional strengthening, rehabilitation and repair in such applications as seismic retrofit, structural preservation, force protection, blast mitigation, and corrosion-related repair and rehabilitation. CSS increases strength without adding weight or mass like traditional strengthening methods.

CSS Reinforcement Solutions for Structural Elements

Reinforcement Type	Structural Element			
	Slab	Beam	Wall	Column/Pile
Externally Applied Laminates	Flexural/Collector	Flexural/Collector	Tensile/Flexural	Flexural
Near-Surface Mounted Laminates	Flexural/Collector	Flexural/Collector	Tensile/Flexural	Flexural
Fabrics	Flexural/Collector	Shear/Flexural/Collector	Shear/Flexural/Tensile	Shear/Flexural/Confinement
FRCM	Flexural/Collector	Shear/Flexural/Collector	Shear/Flexural/Tensile	Shear/Flexural/Confinement

CSS V-Wrap™ Composite Strengthening Systems™



1. **Slab** — Adds collector reinforcement, negative (not shown) and positive moment flexural capacity
2. **Slab opening** — Trim reinforcement
3. **Beam** — Laminates, FRCM or fabrics for flexure and/or collector reinforcement, fabrics or FRCM for shear stirrup reinforcement and potential use of FRP anchors (shown in orange)
4. **Wall** — Stiffening, flexural, shear or tensile reinforcement with FRCM, fabrics and/or laminates (FRCM shown above)
5. **New wall opening** — Trim reinforcement
6. **Column wrapping** — Full column wrap to achieve required strengthening, possibly with additional near-surface mounted laminates, FRCM or fabric for flexure; effective solution for under-reinforced column ties
7. **Protective coating** — High-performance protection against exposure, corrosion, chemical attack, abrasion, fire resistance and other environmental factors



Carbide Drill Bits



SDS-plus® Drill Bits

SDS-plus Shank Bits — Retail Packs

Diameter (in.)	Drilling Depth (in.)	Overall Length (in.)	Quantity (per pack)	Model No.
5/32	4	6 1/4	25	MDPL01506-R25
3/16	2	4 1/4	25	MDPL01804-R25
	4	6 1/4	25	MDPL01806-R25
	6	8 1/4	25	MDPL01808-R25
	8	10	25	MDPL01810-R25
	10	12	25	MDPL01812-R25
	12	14	25	MDPL01814-R25
7/32	4	6 1/4	25	MDPL02106-R25
	6	8 1/4	25	MDPL02108-R25
	8	10	25	MDPL02110-R25
1/4	2	4 1/4	25	MDPL02504-R25
	4	6 1/4	25	MDPL02506-R25
	6	8 1/4	25	MDPL02508-R25
	8	10	25	MDPL02510-R25
5/16	4	6 1/4	25	MDPL03106-R25
3/8	4	6 1/4	25	MDPL03706-R25
	10	12 1/4	25	MDPL03712-R25
1/2	4	6 1/4	25	MDPL05006-R25
	10	12 1/4	25	MDPL05012-R25
5/8	6	8	20	MDPL06208-R20

Carbide Drill Bits

SDS-plus
Retail Packs

SDS-plus® Drill Bits

SDS-plus Shank Bit

SDS-plus bits use an asymmetrical-parabolic flute for efficient energy transmission and dust removal.

SDS-plus Shank Bits

Diameter (in.)	Drilling Depth (in.)	Overall Length (in.)	Model No.
5/32	2	4 1/4	MDPL01504
	4	6 1/4	MDPL01506
3/16	4	6 1/4	MDPL01806
	6	8 1/4	MDPL01808
	8	10	MDPL01810
	10	12	MDPL01812
	12	14	MDPL01814
7/32	4	6 1/4	MDPL02106
	6	8 1/4	MDPL02108
	8	10	MDPL02110
	14	16	MDPL02116
1/4	2	4 1/4	MDPL02504
	4	6 1/4	MDPL02506
	6	8 1/4	MDPL02508
	8	10	MDPL02510
	12	14	MDPL02514
	14	16	MDPL02516
5/16	4	6 1/4	MDPL03106
	10	12	MDPL03112
3/8	4	6 1/4	MDPL03706
	8	10 1/4	MDPL03710
	10	12 1/4	MDPL03712
	16	18	MDPL03718
	22	24	MDPL03724
7/16	4	6 1/4	MDPL04306
	10	12 1/4	MDPL04312

Table continues on the next page.



SDS-plus
Shank Bit

Carbide Drill Bits

SDS-plus® Drill Bits

SDS-plus Shank Bit (cont.)

SDS-plus Shank Bits

Diameter (in.)	Drilling Depth (in.)	Overall Length (in.)	Model No.
½	4	6¼	MDPL05006
	8	10¼	MDPL05010
	10	12¼	MDPL05012
	16	18	MDPL05018
	22	24	MDPL05024
⅜	4	6¼	MDPL05606
	10	12¼	MDPL05612
	16	18	MDPL05618
⅝	6	8	MDPL06208
	10	12	MDPL06212
	16	18	MDPL06218
	22	24	MDPL06224
1⅛	6	8	MDPL06808
¾	6	8	MDPL07508
	8	10	MDPL07510
	10	12	MDPL07512
	16	18	MDPL07518
	22	24	MDPL07524
7⁄8	6	8	MDPL08708
	10	12¼	MDPL08712
	16	18	MDPL08718
1	8	10	MDPL10010
	16	18	MDPL10018

SDS-plus
Shank Bit

SDS-max® Drill Bits

SDS-max and SDS-max Quad Head Shank Bits

Diameter (in.)	Drilling Depth (in.)	Overall Length (in.)	Model No.
3/8	7 1/2	13	MDMX03713
1/2	7 1/2	13	MDMX05013
	15 1/2	21	MDMX05021
9/16	7 1/2	13	MDMX05613
	15 1/2	21	MDMX05621
5/8	7 1/2	13	MDMX06213Q
	15 1/2	21	MDMX06221Q
	30 1/2	36	MDMX06236Q
11/16	15 1/2	21	MDMX06821Q
3/4	8	13	MDMX07513Q
	17	21	MDMX07521Q
	31	36	MDMX07536Q
13/16	17	21	MDMX08121Q
7/8	8	13	MDMX08713Q
	17	21	MDMX08721Q
1	8	13	MDMX10013Q
	17	21	MDMX10021Q
	31	36	MDMX10036Q
1 1/16	18	23	MDMX10623Q
1 1/8	12	17	MDMX11217Q
	17	21	MDMX11221Q
	31	36	MDMX11236Q
1 3/16	18	23	MDMX11823Q
1 1/4	10	15	MDMX12515Q
	18	23	MDMX12523Q
	31	36	MDMX12536Q
1 3/8	12	17	MDMX13717Q
	18	23	MDMX13723Q
1 1/2	18	23	MDMX15023Q
1 3/4	18	23	MDMX17523Q
2	18	23	MDMX20023Q

Model numbers ending with "Q" denote Quad Head.



SDS-max
Shank Bit

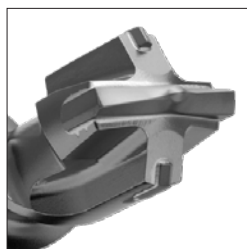

Quad Head

Straight Shank Drill Bits

Straight Shank Bits

Diameter (in.)	Drilling Depth (in.)	Overall Length (in.)	Model No.
1/8	1 3/8	3	MDB01203
3/16	4	6	MDB01806
1/4	2 1/8	4	MDB02504
	4	6	MDB02506
	10	12	MDB02512
5/16	4	6	MDB03106
3/8	4	6	MDB03706
	10	12	MDB03712
7/16	4	6	MDB04306
1/2	4	6	MDB05006
	10	12	MDB05012
5/8	3 1/2	6	MDB06206
3/4	4	6	MDB07506



Straight Shank Bit

Straight Shank Bits – Retail Packs

Diameter (in.)	Drilling Depth (in.)	Overall Length (in.)	Quantity (per pack)	Model No.
3/16	4	6	25	MDB01806-R25
1/4	2 1/8	4	25	MDB02504-R25
	4	6	25	MDB02506-R25
5/16	4	6	25	MDB03106-R25
3/8	4	6	25	MDB03706-R25
1/2	4	6	25	MDB05006-R25

Straight Shank Bits
Retail Packs

Core Bits

Simpson Strong-Tie core bits are made to the same exacting standards as our standard carbide-tipped drill bits. They utilize a centering bit to facilitate accurate drilling in combination hammer/drill mode.

Core Bits with Centering Bit — SDS-max® Shank

Diameter (in.)	Drilling Depth (in.)	Overall Length (in.)	Model No.
2	6¼	22	CBMX20022
2½	6¼	22	CBMX26222
3½	6¼	22	CBMX31222
3½	6¼	22	CBMX35022
4	6¼	22	CBMX40022
5	6¼	22	CBMX50022

Note: With one-piece bits, once coring is begun, the centering bit must be removed using ejector pin. Core bit bodies are 2¼" deep.



**Core Bit
Transfers Energy
Efficiently**



**Core Bit
Center Pilot Bit
(CTRBTF04304)**



**Ejector Key
(CBDEJKEY)**

Demolition Bits

Flat Chisels

General Concrete and Masonry Demolition

Shank Type	Head Width (in.)	Overall Length (in.)	Model No.
SDS-max®	1	12	CHMXF10012
	1	18	CHMXF10018



Flat Chisel

Bull-Point Chisels

General Concrete and Masonry Demolition

Shank Type	Overall Length (in.)	Model No.
SDS-plus®	10	CHPLBP10
SDS-max	12	CHMXBP12
	18	CHMXBP18



Bull-Point Chisel

Asphalt Cutters

Asphalt, Hardpan and Compacted Soil Cutting

Shank Type	Head Width (in.)	Overall Length (in.)	Model No.
SDS-max	3½	16	CHMXAC35016
¾" Hex	3½	16	CHHAC35016



Asphalt Cutter

Ground Rod Drivers

Driving in Ground Rods

Shank Type	Head Width (in.)	Overall Length (in.)	Model No.
SDS-max	7/8	10¼	CHMXRD08710



Ground Rod Driver

Demolition Bits

Scrapers

Removing Tiles, Flooring and Other Materials

Shank Type	Head Width (in.)	Overall Length (in.)	Model No.
SDS-plus®	¾	10	CHPLF07510
	1½	10	CHPLSC15010
SDS-max®	2	12	CHMXSCP20012



Scraper

Bushing Tools One Piece

Concrete and Asphalt Surface Roughening

Shank Type	Head Width (in.)	Overall Length (in.)	Model No.
SDS-max	1¾	9½	CHMXBT17509



Bushing Tool Head

Scalers

Removing Large Quantities of Material

Shank Type	Head Width (in.)	Overall Length (in.)	Model No.
SDS-max	1½	12	CHMXSC15012
	2	12	CHMXSC20012
	3	12	CHMXSC30012



Scaler

Appendix



Appendix



Anchor Products for
Corrosive Environments

pp. 188–193



Light-Frame Construction

pp. 194–195



Retrofit and Repair

pp. 196–197



Crack Injection

pp. 198–199



Wastewater / Water Treatment

pp. 200–201



Bridge and Marine

pp. 202–203



Manufacturing, Maintenance
and Material Handling (OEM)

pp. 204–205



Composite
Strengthening Systems™

pp. 206–207



Cold-Formed Steel Construction

pp. 208–209



Trusted quality, code approved and innovative stainless-steel anchors that can be installed in exterior and corrosive environments.

When it comes to anchorage, specifying a material that can withstand the environment is critical. Proper protection comes from materials that are capable of resisting corrosion while maintaining their strength.

Most anchor products are made from carbon steel. This material is easy to form into a screw or an expansion anchor and can be heat treated to increase its strength and durability. Steel is versatile but can weaken in a corrosive environment. Left unprotected, the iron in the steel will react with oxygen and moisture to form iron oxide — also known as rust.

Environments

There are four levels of corrosive environments (as shown below).

Minimum Corrosion Resistance Recommendations

Corrosion Resistance Classification by Environment	Recommended Product Material or Coating
Low	Zinc plated
Medium	Mechanically galvanized (ASTM B695 — Class 55)
	Hot-dip galvanized (ASTM A153 — Class C)
High	Type 303 or 304 stainless steel
Severe	Type 316 stainless steel



Quick Guide to Choosing the Right Stainless-Steel Grade

High to Severe

A highly corrosive environment is a location where anchors are exposed to chemicals such as fertilizers, soil, acid rain and other corrosive elements. Examples of these environments include kitchens, industrial zones, food-processing facilities, wineries, breweries, outdoor facilities and severe exterior conditions.



Typical high-corrosive environment — central utility plants.



Typical high-corrosive environment — food-processing plants.



Typical severe-corrosive environment — wastewater treatment plants.

Medium

A medium-level corrosive environment is typically a general exterior location where chlorides or corrosive chemical elements are not present. Anchors installed in interior conditions where the anchor is attaching a treated lumber may also require a medium-level corrosive-resistant anchor. Examples of elements at risk to medium-exposure corrosion are stadium seating, exterior handrails, exterior facade anchorages and other components of outdoor facilities.



Typical medium exposure — outdoor seating.



Typical medium-corrosive environment — exterior anchorage.

Low

Finally, low-corrosive environments consist of interior dry spaces. Examples of such applications are warehouse racking, machinery installations, facility catwalk anchorage, interior furniture anchorages and so forth.



Typical low-corrosive environment — interior warehouse.

Anchor Products for Corrosive Environments

Types 304, 316 and 410 stainless-steel products for your job.

Anchor — Stainless-Steel Products	Type 304	Type 316	Type 410
Drop-In (DIA) internally threaded anchor	✓	✓	
Sleeve-All® sleeve anchor	✓		
Stainless-steel Titen HD® heavy-duty screw anchor	✓	✓	
Strong-Bolt® 2 wedge anchor	✓	✓	
Titen® stainless-steel concrete and masonry screw			✓



**Stainless-Steel
Titen HD**
Heavy-Duty
Screw Anchor



**Stainless-Steel
Titen HD
Countersunk**
Heavy-Duty
Screw Anchor



Strong-Bolt 2
Wedge Anchor



**Stainless-Steel
Titen**
Concrete and
Masonry Screw



Sleeve-All
Sleeve Anchor



Drop-In (DIA)
Internally
Threaded Anchor



Concrete Adhesives for Stainless-Steel Threaded Rod



SET-3G™

High-Strength Epoxy Adhesive

- Excellent bond strengths in all applications including submerged, water-filled, damp and dry holes at temperatures between 40°F and 100°F.
- NSF/ANSI standard 61 approved



SET-XP®

High-Strength Epoxy Adhesive

- Install in dry and water saturated holes in base materials with temperatures between 50°F and 110°F
- NSF/ANSI/CAN 61 approved



AT-XP®

High-Strength, Fast-Cure, All-Weather Acrylic Adhesive

- Can be used in cold temperatures as low as 14°F
- NSF/ANSI standard 61 approved

Adhesive Anchor — Stainless-Steel Rods	ASTM A193, Grade B8 and B8M (Types 304 and 316)	ASTM A593 CW (Types 304 and 316)	ASTM A193, Grade B6 (Type 410)
SET-3G	✓	✓	✓
SET-XP	✓		✓
AT-XP	✓		✓



When designing strong and durable anchorage solutions for high and severe corrosive environments, the two most commonly considered materials are Types 304 and 316 stainless steel.

Type 300 Series stainless-steel screw anchors have different corrosion-resistant properties for different environments. When matched to the appropriate environment and application, anchors made from Type 300 Series stainless steel will resist the effects of corrosion and maintain their strength and integrity. Type 316 is the optimal choice for applications in severe corrosive or extreme environments such as salt water, or when chemical or corrosive solutions are present. Type 304 is a cost-effective solution for high corrosive applications where the environment may be wet, moist or damp.

Type 316 Stainless Steel

- Wastewater treatment
- Fertilizer storage buildings
- Sill plates in coastal environments
- Marine/port restoration
- Light rail (transportation)
- Agricultural facilities
- Pulp and paper mills
- Parking structures
- Tunnels
- Balconies in coastal environments
- Outdoor railings in coastal environments





Type 304 Stainless Steel

- Stadium seating
- Curtain walls
- Clean rooms
- Central utility plant facilities
- Food-processing facilities
- Ledger bolts for decks
- DOT signs and fixtures
- Cooling towers
- Scaffolding
- Parking structures
- Balconies
- Refineries
- Breweries and wineries
- Fencing
- Outdoor railings



Light-Frame Construction



Anchoring Adhesives



SET-3G™



AT-XP®



SET-XP®



ET-HP®

Mechanical Anchors



Titen HD®



Titen HD SS



Titen HD
Washer Head



Strong-Bolt® 2



Titen Turbo™

Direct Fastening Systems



Powder-Actuated Systems



PDPAWL



PDPA



Carbide Drill Bits

Framing Hardware
(New and Retrofit)

Titen HD®, Strong-Bolt® 2, Titen HD rod coupler, anchoring adhesives

Post Bases for Decks,
Railings and Patio Covers

Ledgers



Titen HD SS (exterior), Titen HD (interior), Strong-Bolt 2, anchoring adhesives



Titen HD SS, Strong-Bolt 2, anchoring adhesives



Anchoring Adhesives



SET-3G™ AT-XP® SET-XP® ET-HP®



Opti-Mesh Screen Tube



Steel Screen Tube



Piston Plug

CI Structural Injection Epoxy



Available in five formulations (CI-SLV, CI-LV, CI-LV FS, CI-LPL and CI-GV) for cracks ranging from 0.002" to 1/4" (0.05 mm to 6.4 mm).

Mechanical Anchors



Titen HD® Titen HD SS Titen HD CS Titen HD CS SS Titen Turbo™



Strong-Bolt® 2 Strong-Bolt 2 SS Sleeve-All Sleeve-All SS



Drop-In Drop-In SS Hollow Drop-In Heli-Tie™



RPS-263



Composite Strengthening Systems™ (CSS V-Wrap™)

FRP, FRCM,
Laminate,
FRP Anchors,
Epoxy Saturant,
Paste, Coatings



Rebar and Smooth Dowelling



Anchoring adhesives

Seismic Retrofit / Structural Renovation



Titen HD®, Strong-Bolt® 2, anchoring adhesives

Architectural Attachments



Titen HD, Strong-Bolt 2, Titen Turbo™, anchoring adhesives

Concrete Formwork



Titen HD, DSD, Strong-Bolt 2

Concrete / Unreinforced Masonry (URM) Retrofit



CSS laminates and CSS-EP



Carbon and E-glass FRP Fabrics



Fabric-Reinforced Cementitious Matrix (FRCM)



Crack Injection



CI Structural Injection Epoxy



CI-SLV

CI-LV

CI-LV FS

CI-LPL

CI-GV

Crack Injection



Crack-Pac®

Crack-Pac Flex-H2O™

Paste-Over and Crack Sealants



CIP-LO

CIP-F



ETR-16

Accessories



Optimix® Mixing Nozzle



E-Z-Click™
Ports and Injection Fitting



EIPX-EZ Corner-Mount/
Drilled-In Port



EIP-EZA
Flush-Mount Port



Crack Injection

Crack Injection in Concrete Slabs, Walls, Columns and Beams to Restore Structural Integrity



CI-LV, CI-LV FS, CI-GV, CI-SLV, CI-LPL

Gravity Feed for Cracks in Floors



CI-LV, CI-LV FS, CI-SLV, CI-LPL, Crack-Pac®, Crack-Pac Flex-H₂O™

Crack Injection in Swimming Pools



CI-LV, CI-LV FS, CI-GV, CI-SLV, CI-LPL, Crack-Pac, Crack-Pac Flex-H₂O

Dowels to Reinforce Replaced Concrete



Anchoring adhesives



Wastewater / Water Treatment



For more information, please visit strongtie.com/solutions/wastewater.

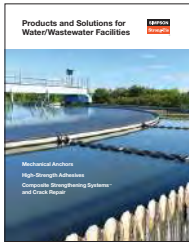

Flier S-A-WWT

Anchoring Adhesives



SET-3G™

AT-XP®

SET-XP®

ET-HP®

Mechanical Anchors



Titen HD® SS

Titen HD CS SS

Strong-Bolt® 2 SS

Sleeve-All SS

Drop-In SS

CI Structural Injection Epoxy



Available in five formulations (CI-SLV, CI-LV, CI-LV FS, CI-LPL and CI-GV) for cracks ranging from 0.002" to 1/4" (0.05 mm to 6.4 mm).

Crack Injection



Crack-Pac® Flex-H₂O™



Wastewater / Water Treatment

Composite Strengthening Systems™ (CSS V-Wrap™)

FRP, FRCM, Laminate, FRP Anchors, Epoxy Saturant, Paste, Coatings



Crack Injection — Paste-Over and Crack Sealants



CIP-LO



CIP-F



ETR-16

Carbide Drill Bits



Pumps and Equipment



Titen HD® SS, Strong-Bolt® 2 SS, anchoring adhesives

Concrete / URM Retrofit



CSS laminates and CSS-EP

Gates



Titen HD® SS, Strong-Bolt® 2 SS, anchoring adhesives

Pipe Supports



Titen HD, Titen HD threaded rod hanger, Strong-Bolt 2, Wedge-All, Drop-In



Bridge and Marine



Anchoring Adhesives



SET-3G™

AT-XP®

SET-XP®

ET-HP®

CI Structural Injection Epoxy



Available in five formulations (CI-SLV, CI-LV, CI-LV FS, CI-LPL and CI-GV) for cracks ranging from 0.002" to ¼" (0.05 mm to 6.4 mm).

Mechanical Anchors



Titen HD® SS

Titen HD CS SS

Strong-Bolt® 2 SS

Sleeve-All SS

Drop-In SS

Appendix

Composite Strengthening Systems™ (CSS V-Wrap™)

FRP, FRCM, Laminate, FRP Anchors, Epoxy Saturant, Paste, Coatings





Concrete Formwork



Titen HD® SS, Strong-Bolt® 2 SS

Barriers and Guardrails



Titen HD SS, Strong-Bolt 2 SS,
anchoring adhesives

Heavy- and Light-Duty Signs



Titen HD SS, Strong-Bolt 2 SS,
anchoring adhesives

Attaching Precast Elements



Titen HD SS, Strong-Bolt 2 SS,
anchoring adhesives

Dowels for Jersey Barriers



Anchoring adhesives

Glare Screens



Titen HD SS, Strong-Bolt 2 SS,
anchoring adhesives

Composite Strengthening Systems™ (CSS V-Wrap™)



Underwater and marine coatings



Anchoring Adhesives



SET-3G™



AT-XP®



SET-XP®



ET-HP®

Mechanical Anchors



Titen HD®



Titen HD SS



Titen HD CS



Strong-Bolt® 2



Strong-Bolt 2 SS



Titen Turbo™



Racking



Titen® HD, Strong-Bolt® 2

Dock Doors and Bumpers



Titen HD SS, Strong-Bolt 2 SS,
anchoring adhesives

Conveyors and Rollers



Titen HD, Strong-Bolt 2, anchoring adhesives

Steel Beams / Columns



Titen HD, Strong-Bolt 2, anchoring adhesives

Stadium Seating



Titen HD, Strong-Bolt 2, anchoring adhesives

Awnings



Titen HD, Strong-Bolt 2, anchoring adhesives



Smarter Strengthening Solutions



A Strong Alliance for Stronger Structures

Through their alliance, Simpson Strong-Tie and Structural Technologies offer one-stop, end-to-end concrete and masonry strengthening and repair solutions with the best products, installation and support available.

CI Structural Injection Epoxy



CI-SLV

CI-LV

CI-LV FS

CI-LPL

CI-GV

Crack Injection



Crack-Pac®

Crack-Pac Flex-H2O™

Paste-Over and Crack Sealants



CIP-LO

CIP-F

ETR-16

Composite Strengthening Systems™ (CSS V-Wrap™)

Applications:

Seismic Retrofit

- Shear strengthening
- Displacement/ductility
- Life safety

Load Rating Upgrade

- Increased loads
- New equipment
- Change of use

Damage Repair

- Deterioration/corrosion
- Blast/vehicle impact

Defect Remediation

- Size/layout errors
- Low concrete strengths

Blast Mitigation

- Hardening
- Progressive collapse

Buildings



Underwater



Bridges



Piers and Wharfs



Tanks / Silos



Tunnels

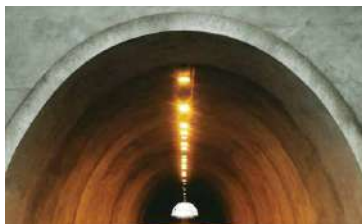

Parking Structures



Pipes

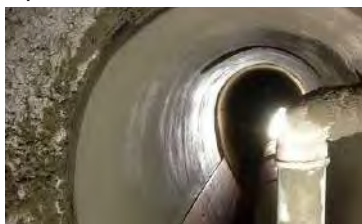

Cold-Formed Steel Construction



Mechanical Anchors



Titen HD®



Strong-Bolt® 2



Crimp Drive®



Titen Turbo™



CSD Split-Drive



Zinc Nailon™

Direct Fastening Systems



Powder-Actuated Systems



Gas-Actuated System



PDPAWL



PDPA



PDPAT



GDP



GDPS

Cold-Formed Steel Construction

CFS Curtain Walls



Concrete Floor Slab



Titen Turbo™ screw

Bypass Steel Connections



Direct fastening systems

Bypass Connections (Concrete or Steel)

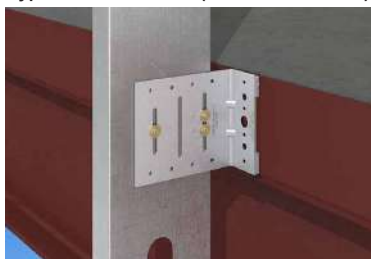

Titen HD®, Strong-Bolt® 2 to concrete and direct fastening systems to steel

Bottom Track



Split-Drive, Crimp Drive®, Zinc Nailon™, direct fastening systems

Ceiling Track



Split-Drive, Crimp Drive®, Zinc Nailon™, direct fastening systems

Low-Post or Kneewall Framing



RCKW kneewall connection with Titen HD, Strong-Bolt 2 or anchoring adhesives

Bypass Floor Slab or Steel Attachment



Titen HD to concrete and direct fastening systems to steel

Length Identification Head Marks

General Installation Guide / Instructions

The following tables define the length of various Simpson Strong-Tie® mechanical anchors based upon the letter stamped on the anchor head. The lengths represented are in inches.

This information pertains to the following Simpson Strong-Tie mechanical anchors:

- Strong-Bolt® 2
- Sleeve-All®

Length Identification Head Marks

Mark	Units	A	B	C	D	E	F	G	H	I
From	in.	1½	2	2½	3	3½	4	4½	5	5½
Up To But Not Including	in.	2	2½	3	3½	4	4½	5	5½	6

Length Identification Head Marks

Mark	Units	J	K	L	M	N	O	P	Q	R
From	in.	6	6½	7	7½	8	8½	9	9½	10
Up To But Not Including	in.	6½	7	7½	8	8½	9	9½	10	11

Length Identification Head Marks

Mark	Units	S	T	U	V	W	X	Y	Z
From	in.	11	12	13	14	15	16	17	18
Up To But Not Including	in.	12	13	14	15	16	17	18	19

Acceptable Hole Diameter

Mechanical Anchors

Pre-Load Relaxation

Expansion anchors that have been set to the required installation torque in concrete will experience a reduction in pre-tension (due to torque) within several hours. This is known as pre-load relaxation. The high compression stresses placed on the concrete cause it to deform, which results in a relaxation of the pre-tension force in the anchor. Tension in this context refers to the internal stresses induced in the anchor as a result of applied torque and does not refer to anchor capacity. Historical data shows it is normal for the initial tension values to decrease by as much as 40–60% within the first few hours after installation. Retorquing the anchor to the initial installation torque is not recommended or necessary.

Adhesive Anchors

Installation into Green Concrete

The strength design data for adhesive anchors in this catalog are based on installations into concrete that is at least 21 days old. For anchors installed into concrete that has cured for less than 21 days, refer to the following modification factors that should be applied to the published adhesive bond strength.

Products	Concrete Age When Installed	Concrete Age When Loaded	Bond Strength Factor
SET-3G SET-XP AT-XP ET-HP	14 days	21 days	1.0
		14 days	0.9
	7 days	21 days	1.0
		7 days	0.7

Oversized Holes

The performance data for adhesive anchors are based upon anchor tests in which holes were drilled with carbide-tipped drill bits of the same diameter listed in the product's load table. Additional static tension tests were conducted to qualify anchors installed with SET-3G™, SET-XP® and ET-HP® adhesives for installation in holes with diameters larger than those listed in the load tables. The tables indicate the acceptable range of drilled hole sizes and the corresponding tension-load reduction factor (if any). The same conclusions also apply to the published shear load values. Drilled holes outside of the accepted range shown in the charts are not recommended.

SET-3G Adhesive — Acceptable Hole Diameter

Insert Diameter (in.)	Acceptable Hole Diameter Range (in.)	Acceptable Load Reduction Factor
½	⅜ – ¾	1.0
⅝	1¼ – 7⁄8	1.0
¾	7⁄8 – 1	1.0
7⁄8	1 – 1½	1.0
1	1½ – 1¼	1.0
1¼	1¾ – 1½	1.0

Acceptable Hole Diameter

Adhesive Anchors (cont.)

Oversized Holes (cont.)

SET-XP® and ET-HP® Adhesives — Acceptable Hole Diameter

Insert Diameter (in.)	Acceptable Hole Diameter Range (in.)	Acceptable Load Reduction Factor
1/2	5/8 – 3/4	1.0
5/8	3/4 – 15/16	1.0
3/4	7/8 – 1 1/8	1.0
7/8	1 – 1 5/16	1.0
1	1 1/8 – 1 1/2	1.0
1 1/4	1 3/8 – 1 7/8	1.0

AT-XP® Adhesive — Acceptable Hole Diameter

Insert Diameter (in.)	Acceptable Hole Diameter Range (in.)	Acceptable Load Reduction Factor
3/8	7/16 – 1/2	1.0
1/2	9/16 – 5/8	1.0
5/8	1 1/16 – 3/4	1.0

Core-Drilled Holes

The performance data for adhesive anchors are based upon anchor tests in which holes were drilled with carbide-tipped drill bits. Additional static tension tests were conducted to qualify anchors installed with SET-3G™, SET-XP and ET-HP anchoring adhesives for installation in holes drilled with diamond-core bits. In these tests, the diameter of the diamond-core bit matched the diameter of the carbide-tipped drill bit recommended in the product's load table. SET-3G, SET-XP, and ET-HP anchoring adhesive require a reduction factor of 0.7 applied to the characteristic bond strength (τ_k). The same conclusions also apply to the published allowable shear loads. Tests conducted in core-drilled holes are for non-IBC jurisdictions.

Acceptable Hole Diameter

Adhesive Anchors (cont.)

Installation in Water-Saturated Concrete, Water-Filled Holes and Submerged Environments

SET-3G™, SET-XP®, ET-HP® and AT-XP®:

The performance data for adhesive anchors using SET-3G, SET-XP, ET-HP and AT-XP adhesives are based upon tests according to ICC-ES AC308. This criteria requires adhesive anchors that are to be installed in outdoor environments to be tested in water-saturated concrete holes that have been cleaned with less than the amount of hole cleaning recommended by the manufacturer. A product's sensitivity to this installation condition is considered in determining the product's "Anchor Category" (strength reduction factor).

SET-XP, ET-HP and AT-XP may be installed in dry or water-saturated concrete.

SET-3G may be installed in dry or water-saturated concrete, in water-filled holes and in submerged concrete.

Reliability Testing per ICC-ES AC308 Is Defined As:

- Dry Concrete — Cured concrete whose moisture content is in equilibrium with surrounding non-precipitate atmospheric conditions.
- Water-Saturated Concrete — Concrete that has been exposed to water over a sufficient length of time to have the maximum possible amount of absorbed water into concrete pores to a depth equal to the anchor embedment.
- Submerged Concrete — Water-saturated concrete that is fully submerged at the time of hole drilling and anchor installation.
- Water-Filled Hole — Drilled hole in water-saturated concrete that is clean yet contains standing water at the time of installation.

Alphabetical Index of Products

3GWSP	Opti-Mesh Adhesive-Anchoring Screen Tube	36
ADT	Acrylic Dispensing Tool	29
AMN	Acrylic Mixing Nozzle	30
ARC	Adhesive Retaining Caps	35
AT-XP	Acrylic Adhesive	26
ATR	All Thread Rod	41
ATS	Acrylic Screens	38
AWSP	Opti-Mesh Adhesive-Anchoring Screen Tube	36
CD	Crimp Drive® Anchor	102
CDT10S	Adhesive Dispensing Tool	28
CI-SLV	Super-Low-Viscosity Injection Epoxy	140
CI-LV	Low-Viscosity Injection Epoxy	142
CI-LV FS	Low-Viscosity Fast-Setting Injection Epoxy	144
CI-LPL	Low-Viscosity Long-Pot-Life Injection Epoxy	146
CI-GV	Gel-Viscosity Injection Epoxy	148
CIP-F	Crack Injection Paste Over	154
CIP-LO	Low Odor Crack Injection Paste Over	154
CPFH	Crack-Pac® Flex-H ₂ O™ Crack Sealer	152
CSD	Countersunk Split Drive	105
CSS V-Wrap™	Composite Strengthening Systems™	172
DIA	Drop-In Anchor	94
DIAB	Drop-In Anchor	88
DSD	Duplex Head Split Drive	105
EDT	Epoxy Dispensing Tool	28
EIF	Injection Fitting	156
EIP	Injection Port	156
EMN	Epoxy Mixing Nozzle	30
ET-HP®	Epoxy Adhesive	24
ETB	Hole-Cleaning Brush	32

Alphabetical Index of Products

ETBR	Hole-Cleaning Brush	32
ETBS	Hole-Cleaning Brush	31
ETIPAC	Crack-Pac® Injection Epoxy	150
ETR	Concrete Repair and Paste-Over Epoxy	155
ETS	Epoxy Screens	38
EWSP	Opti-Mesh Adhesive-Anchoring Screen Tube	36
EZAC	Easy-Set Pin-Drive Anchor	71
E-Z-Click™	Injection System	156
GAC	Gas-Actuated Ceiling 90° Clip	119
GCC	Gas-Actuated Conduit Clip	119
GCL	Gas-Actuated Conduit Clamp	119
GCN-MEP	Gas-Actuated Concrete Nailer	114
GCT	Gas-Actuated Tie-Strap Holder	119
GDP	Collated Gas-Drive Pins	116
GDPS	Collated Gas-Drive Step-Shank Pins	116
GDPSK	Collated Spiral-Knurled Gas Pins	117
GFC	Gas Fuel Cell	118
GMR	Magnetic Ring for GCN-MEPMAGKT	117
GRH	Gas-Actuated Threaded Rod Hanger	119
GTH	Gas-Actuated Top-Hat Pin	119
GTS	Gas-Actuated ¼" Threaded Stud	119
GW	Gas-Actuated Dome Washer Pin	119
GWL	Lathing Washer for GCN-MEPMAGKT	117
HDIA	Hollow Drop-In Anchor	96
HELI	Helix-Tie Helical Wall and Stitching Tie	166
P22AC	0.22 Caliber "A" Crimp Loads — Single Shot	129
P25SL	0.25 Caliber Plastic 10-Shot Strip Loads	129
P27LVL	0.27 Caliber Single-Shot Loads — Long	130
P27SL	0.27 Caliber Plastic 10-Shot Strip Loads	130

Alphabetical Index of Products

PBXDP	BX Cable Strap	135
PCC	Conduit Clip	135
PCL	90° Ceiling Clip (no pin)	133
PCLDPA	90° Ceiling Clip Angle with Pin	133
PDPA	0.157" Shank Diameter Drive Pin	132
PDPAS	Collated 0.157" Shank Diameter Drive Pin	133
PDPAT	0.157" Shank Diameter Top-Hat Fastener	133
PDPAWL	0.157" Shank Diameter with 1" Metal Washer	132
PECLDPA	120° Ceiling Clip Angle with Pin	133
PEPT	Extension Poles for PT-27, PTP-27L and GCN-MEPMAGKT	120
PHBC	Highway Basket Clip	135
PHD	¼"-Headed Hammer Drive Fastener	136
PHT-38	Manual Hammer Tool	136
PINW	0.145" Shank Diameter Drive Pin with 1 7/16" Metal Washer	134
PINWP	0.145" Shank Diameter Drive Pin with 1 3/8" Plastic Washer	134
PKP	Concrete Forming Pin	136
PP	Piston Plug	33
PPFT	Piston Plug Flexible Tubing	34
PSLV3	3/8" Threaded Stud	135
PT-22A	0.22 Cal. Powder-Actuated Tool	126
PT-22HA	0.22 Cal. Single-Shot Hammer-Actuated Tool	128
PT-27	0.27 Cal. Semi-Automatic Powder-Actuated Tool	124
PTP-27L	0.27 Cal. Automatic Powder-Actuated Tool	122
PTRHA	0.157" Shank Diameter Threaded Rod Hanger	134
RFB	Retrofit Bolt	40
RND	Rod Hanger Nut Driver	83
RSH	Steel Rod Hanger – Horizontal	83
RSV	Steel Rod Hanger – Vertical	83
RWH	Wood Rod Hanger – Horizontal	86

Alphabetical Index of Products

RWV	Wood Rod Hanger – Vertical	86
SDS-max®	Drill Bits	181
SDS-plus®	Drill Bits	178
SET-3G™	Epoxy Adhesive	20
SET-XP®	Epoxy Adhesive	22
SL	Sleeve-All® Anchor	68
STB2	Strong-Bolt® 2 Wedge Anchor	64
STB2 SS	Strong-Bolt 2 Type 304 Stainless-Steel Wedge Anchor	64
SWN	Sure Wall Anchor – Nylon	107
SWZ	Sure Wall Anchor – Zinc	107
THD	Titen HD® Heavy-Duty Screw Anchor	52
THD CS	Titen HD Countersunk Screw Anchor	54
THD CS SS	Stainless-Steel Titen HD Countersunk Screw Anchor	60
THD RC	Titen HD Rod Coupler	62
THD RH	Titen HD Rod Hanger	81
THD SS	Stainless-Steel Titen HD Heavy-Duty Screw Anchor	58
THD-WH	Titen HD Washerhead Screw Anchor	55
TNT	Titen Turbo™ Screw Anchor	74
TTN SS	Titen® Stainless-Steel Concrete and Masonry Screw	79
TW	Tie Wire Anchor	73
ZN	Zinc Nailon™	100

Strength runs in the family.



TITEN
SCREW ANCHORS

The Titen® family of concrete and masonry anchoring solutions from Simpson Strong-Tie. Our broad range of versatile and innovative screw anchors is designed for maximum ease and efficiency — ensuring a quick, smooth installation every time. And our skilled field support teams are always available to assist on the jobsite.

To learn more about our full line of easy-to-install Titen solutions, visit go.strongtie.com/titenfamily or call (800) 999-5099.

SIMPSON

Strong-Tie

